



PSE

Refrigeration Dryer (60Hz)

EN User Manual
ES Manual de uso
FR Manuel d'utilisation

PSE 325
PSE 400
PSE 500
PSE 700
PSE 800
PSE 1000

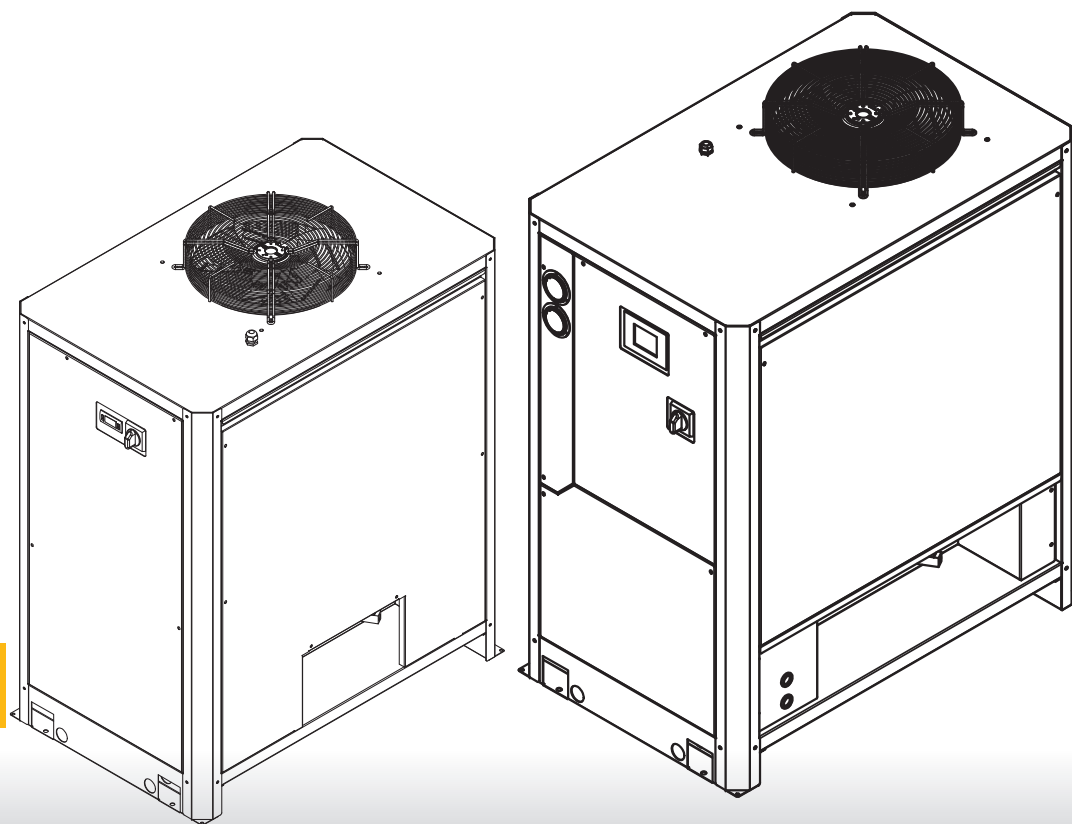

DATE: 08.03.2024 - Rev. 16
CODE: 398H271746



Index

1 Safety	2
1.1 Importance of the manual.....	2
1.2 Warning signals.....	2
1.3 Safety instructions.....	2
1.4 Residual risks.....	2
2 Introduction	3
2.1 Transportation.....	3
2.2 Handling.....	3
2.3 Inspection.....	3
2.4 Storage.....	3
3 Installation	3
3.1 Procedures.....	3
3.2 Operating space.....	3
3.3 Condenser version.....	3
3.4 Tips.....	3
3.5 Electrical connection.....	3
3.6 Condensate drain connection.....	3
4 Commissioning	4
4.1 Preliminary checks.....	4
4.2 Starting.....	4
4.3 Operation.....	4
4.4 Stop.....	4
5 Control (325-500)	5
5.1 Control panel.....	5
5.2 Symbol.....	5
5.3 Parameter settings.....	5
5.4 Configuration condensate drain.....	6
5.5 Visualization of temperature probes.....	6
5.6 Modbus ON/OFF.....	7
5.7 ON/OFF remoto.....	7
5.8 CYCLING function.....	8
5.9 Alarm management.....	8
5.10 Alarm history.....	9
5.11 Setting clock/date.....	9
5.12 Software version.....	10
5.13 Default parameter.....	10
6 Control Touch (700-1000)	10
6.1 Control panel "Touch".....	10
6.2 Information menu.....	11
6.2.1 Setting parameter date/time.....	11
6.2.2 Setting parameter menu.....	12
6.2.3 Probe menu.....	16
6.2.4 Digital input menu.....	16
6.2.5 Digital output menu.....	17
6.2.6 Serial number menu.....	17
6.3 Rapid menu.....	18
7 Maintenance	18
7.1 General instructions.....	18
7.2 Refrigerant.....	18
7.3 Preventive Maintenance Programme.....	19
7.4 Dismantling.....	19
8 Troubleshooting	20
9 Appendix	

1 Safety

1.1 Importance of the manual

- Keep it for the entire life of the machine.
- Read it before any operation.
- It is subject to changes: for updated information see the version on the unit.

1.2 Warning signals



Instruction for avoiding danger to persons.



Instruction for avoiding damage to the equipment.



The presence of a skilled or authorized technician is required.



There are symbols whose meaning is given in the para. 9.1

1.3 Safety instructions

- Every unit is equipped with an electric disconnecting switch for operating in safe conditions. Always use this device in order to eliminate risks maintenance.
- The manual is intended for the end-user, only for operations performable with closed panels: operations requiring opening with tools must be carried out by skilled and qualified personnel.
- Do not exceed the design limits given on the data plate.
- It is the user's responsibility to avoid loads different from the internal static pressure. The unit must be appropriately protected whenever risks of seismic phenomena exist.
- The safety devices on the compressed air circuit must be provided for by the user.
- The dimensioning of the safety devices of the air compressed circuit must be according to the specifications of the system and legislation in force locally. Only use the unit for professional work and for its intended purpose. The user is responsible for analyzing the application aspects for product installation, and following all the applicable industrial and safety standards and regulations contained in the product instruction manual or other documentation supplied with the unit. Tampering or replacement of any parts by unauthorized personnel and/or improper machine use exonerate the manufacturer from all responsibility and invalidate the warranty. The manufacturer declines present or future liability for damage to persons, things and the machine, due to negligence of the operators, non-compliance with all the instructions given in this manual, and

non-application of current regulations regarding safety of the system. The manufacturer declines any liability for damage due to alterations and/or changes to the packing. It is the responsibility of the user to ensure that the specifications provided for the selection of the unit or components and/or options are fully comprehensive for the correct or foreseeable use of the machine itself or its components.

IMPORTANT: The manufacturer reserves the right to modify this manual at any time. The most comprehensive and updated information, the user is advised to consult the manufacturer.

1.4 Residual risks

The installation, start up, stopping and maintenance of the machine must be performed in accordance with the information and instructions given in the supplied technical documentation and always in such a way to avoid the creation of a hazardous situation. The risks that it has not been possible to eliminate in the design stage are listed in the following table:

Part affected	Residual risk	Manner of exposure	Precautions
heat exchanger coil	small cuts	contact	avoid contact, wear protective gloves
fan grill and fan	lesions	insertion of pointed objects through the grill while the fan is in operation	do not poke objects of any type through the fan grille or place any objects on the grill
inside the unit: compressor and discharge pipe	burns	contact	avoid contact, wear protective gloves
inside the unit: metal parts and electrical wires	intoxication, electrical shock, serious burns	defects in the insulation of the power supply lines upstream of the electrical panel; live metal parts	adequate electrical protection of the power supply line; ensure metal parts are properly connected to earth
outside the unit: area surrounding the unit	intoxication, serious burns	fire due to short circuit or overheating of the supply line upstream of the unit's electrical panel	ensure conductor cross-sectional areas and the supply line protection system conform to applicable regulations

2 Introduction

This manual is in reference to refrigeration dryers designed to remove water vapor from compressed air.

2.1 Transportation

The packed unit must:

- remain upright;
- be protected against atmospheric agents;
- be protected against impacts.

2.2 Handling

Use a fork-lift truck suitable for the weight to be lifted, avoiding any type of impact.

2.3 Inspection

- All the units are assembled, wired, charged with refrigerant and oil and tested under standard operating conditions in the factory;
- on receiving the machine check its condition: immediately notify the transport company in case of any damage;
- unpack the unit as close as possible to the place of installation.

2.4 Storage

If several units have to be stacked, follow the notes given on the packing. Keep the unit packed in a clean place protected from damp and bad weather.

3 Installation

 Install indoors in a clean, dry area that is protected from the elements, direct sunlight and/or other harsh conditions.

 The product installed must be suitably protected against fire risk (Ref. EN378-3).

3.1 Procedures

 Comply with the instructions given in par. 9.2 and 9.3.

All dryers must be fitted with adequate pre-filtration near the dryer air inlet. Seller is excluded any obligation of compensation or refund for any direct or indirect damage caused by its absence.

 Pre-filter element (for 3 micron filtration or better) must be replaced at least once a year, or sooner as per manufacturer recommendations.

 Correctly connect the dryer to the compressed air inlet/outlet connections.

3.2 Operating space

 Leave a space of 1.5 m around the unit.

Leave a space of 2 m above dryer models with vertical condensation air expulsion.

3.3 Condenser version



Air-cooled version (Ac)

Do not create cooling air recirculation situations.

Do not obstruct the ventilation grilles.

Water-cooled version (Wc)

If not provided in the supply, fit a mesh filter on the condensation water inlet.

  Inlet condensation water characteristics:

Temperature	≥50°F (10°C)	CL ⁻	<50 ppm
ΔT IN/OUT	5-15°C	CaCO ₃	70-150 ppm
Max % glycol	50	O ₂	<0.1 ppm
Pressure	43.5-145 PSIG (3-10 barg)	Fe	<0.2 ppm
PH	7.5-9	NO ₃	<2 ppm
Electrical conductivity	10-500 μS/cm	HCO ₃ ⁻	70-300 ppm
Langelier saturation index	0-1	H ₂ S	<0.05 ppm
SO ₄ ²⁻	<50 ppm	CO ₂	<5 ppm
NH ₃	<1 ppm	Al	<0.2 ppm

Please note that for special cooling water types such as demineralized, deionized or distilled it is necessary to contact the manufacturer to verify which kind of condenser should be used since the standard material may not be suitable.

3.4 Tips

To prevent damage to the internal parts of the dryer and air compressor, avoid installations where the surrounding air contains solid and/or gaseous pollutants (e.g. sulphur, ammonia, chlorine and installations in marine environments).

The ducting of extracted air is to be avoided for versions with axial fans.

3.5 Electrical connection

Use approved cable in conformity with the local laws and regulations (for minimum cable section, see par. 9.3).

Install a differential thermal magnetic circuit breaker with contact opening distance 3 mm ahead of the system (RCCB - IDn = 0.3A) (see the relevant current local regulations).

The nominal current In of the magnetic circuit breaker must be equal to the FLA with an intervention curve type D.

Select the power supply and insert a bridge as shown below:

S7-S6 for 400/3/50

S8-S6 for 460/3/60

Inside the electrical panel there is an instruction label.

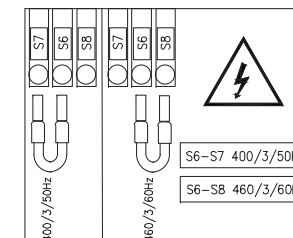

3.6 Condensate drain connection

 Make the connection to the draining system, avoiding connection in a closed circuit shared by other pressurized discharge lines. Check the correct flow of condensate discharges. Dispose of all the condensate in conformity with current local environmental regulations.

4 Commissioning

4.1 Preliminary checks

Before commissioning the dryer, make sure:

- installation was carried out according that given in the section 3;
- the air inlet valves are closed and that there is no air flow through the dryer;
- the power supply is correct;
- with Wc version, open the cooling water circuit a few minutes before starting the dryer.

4.2 Starting

1. switch the power on by turning the MAIN SWITCH "" to "I ON": the touch is powered.

(for model 325-500)there is a label under the control to informe that:

 **THE CRANKCASE HEATER MUST BE SWITCHED ON 12 HOURS BEFORE STARTING THE DRYER.**
(for model 700-1000) appear on display:

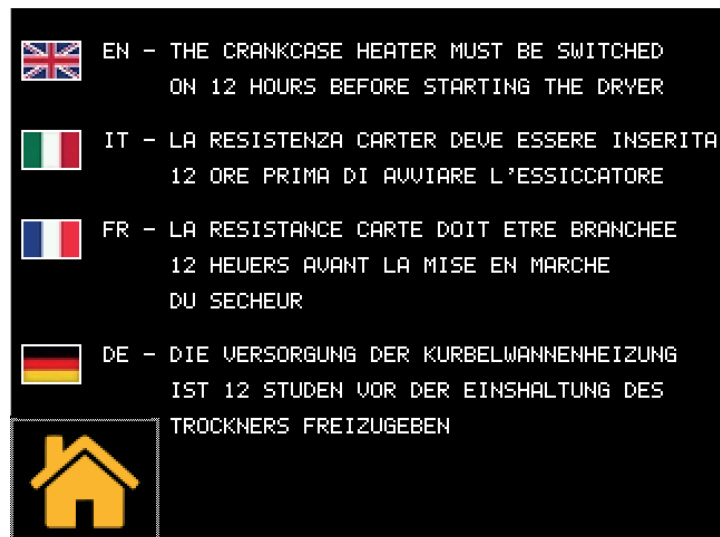

touch  to see home screen

2. Press  to start (for model 325-500).

Press  to start (for model 700-1000).

3. Start the dryer before the air compressor;

 Fan (Ac version): if connected with the wrong phase sequence they turn in the opposite direc-

tion, with the risk of being damaged (in this case the air exits the dryer cabinet from the condenser grilles instead from the fan grille - see par. 9.8 (appenix) for correct air flow); immediately invert two phases.

4. Wait 5 minutes, then slowly open the air inlet valve;

5. slowly open the air outlet valve: the dryer is now drying.

Phases Monitor

If appears to display an alarm, during the start up of the dryer, the user must verify the wiring of the input terminals of the disconnecting switch of the dryer.

4.3 Operation

- Leave the dryer on during the entire period the air compressor is working;
- The dryer operates in automatic mode, therefore field settings are not required;
- In the event of unforeseen excess air flows, by-pass to avoid overloading the dryer.
- Avoid inlet air temperature fluctuations.

4.4 Stop

1. Stop the dryer 2 minutes after the air compressor stops or in any case after interruption of the air flow;

2. make sure compressed air does not enter the dryer when the dryer is disconnected or if an alarm occurs.

3. Press  to stop the dryer (for model 325-500).

Press  to stop the dryer (for model 700-1000).

4. Turn the MAIN SWITCH "" to "O OFF" to switch the power off.

 **Wc version**, close the water circuit with the dryer stopped.

5 Control (325-500)

5.1 Control panel



- UP button: press to increase the value of a selected editable parameter.
PRESSED FOR 3s START MANUAL CONDENSATE DRAIN
- DOWN button: press to decrease the value of a selected editable parameter.
- ESC button : to exit without saving; returns to the previous level;
PRESSED FOR 5s. ALARM RESET.
- SET button : to exit and saving/ confirm the value; go to the next level; enter on Set Menu;
PRESSED FOR 5s. START DRYER.
- : press together at the same time to enter on the parameters of the program.

5.2 Symbol

Symbol	Symbol status	Function	Symbol	Symbol status	Function
	Lit up	compressor ON		illuminated	Dryer ON Compressor OFF
	Off	compressor OFF			
	Lit up	dryer ON		illuminated	Maintenance
	Flashing	dryer OFF			
	Lit up	Alarm present	°C °F	illuminated	grade
	Flashing	Warning present			
	Off	No alarm present			
	Lit up	Condensate drain ON	Bar PSI	illuminated	pressure
	Off	Condensate drain OFF			

5.3 Parameter settings

Temperature measurement unit

How to set the temperature measurement unit.

1. Press **set** and **esc** together at the same time to enter general menu "PAr".
2. Press **set** to find menu "CF9".
3. Press **set** to enter .
4. Use the arrows or to find the menu "R1".
5. Press **set** to choose: ON = Fahrenheit (PSI) / OFF = Celsius(bar).
6. Press **set** to confirm.
7. Press **esc** to exit.

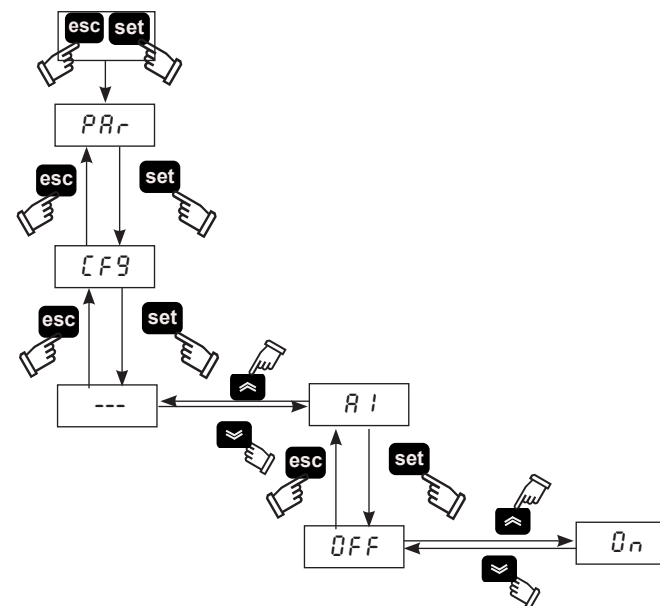

5.4 Configuration condensate drain

There are three modes of operation:

- CAPACITIVE = Automatic drain using a capacitive sensor;
- TIMED = programmable draining times;
- CONTINUOUS (external) = if there is an external drain.

1. Press **set** and **esc** together at the same time to enter general menu "PAr".
2. Press **set** to enter.
3. Use the arrows **⏴** or **⏵** to find menu "Cd".
4. Press **set** to enter.
5. Use the arrows **⏴** or **⏵** to find parameter "d3".
6. Press **set** to choose the type of the drain:
 - 0 = external;
 - 1 = timed;
 - 2 = capacitive.
7. Press **set** for five seconds to select the drain.

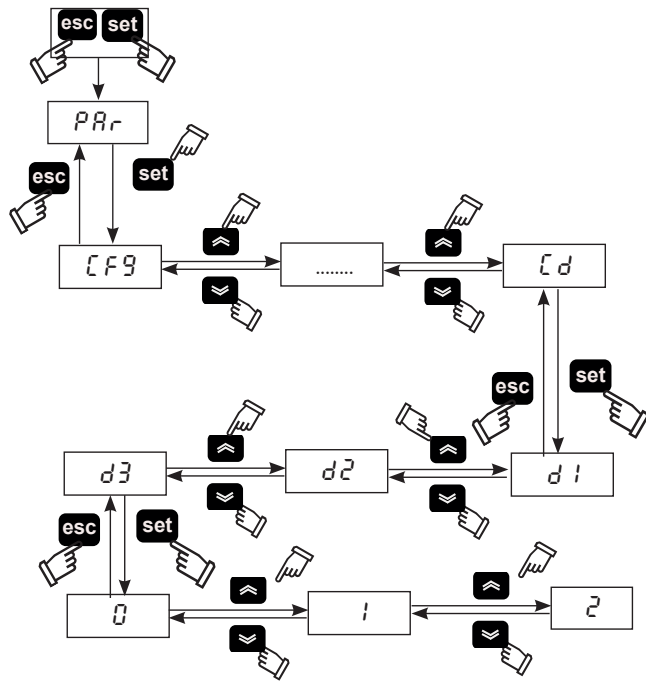

For the option **(1)** timed drain, it is possible to set the ON/OFF time of the drain. On menu "Cd"

1. Use the arrows **⏴** or **⏵** to find the parameter "d1" to set the opening time.
2. Press **set** to confirm.

3. Use the arrows **⏴** or **⏵** to find the parameter "d2" to set the closing time.
4. Press **set** to confirm.
5. Press **esc** to exit.

5.5 Visualization of temperature probes

On display appear the dew point temperature as default.

To view other temperatures, proceed as follows:

1. Use the arrows **⏴** or **⏵** choose the sensor.
 - b0 = dew point temperature sensor;
 - b2 = evaporation temperature sensor;
 - b5 = Suction compressor temperature sensor;
 - b8 = condensation temperature sensor;
 - P1 = High pressure sensor

Once chosen wait a few seconds and the probe value will appear.

2. Press **esc** to exit.

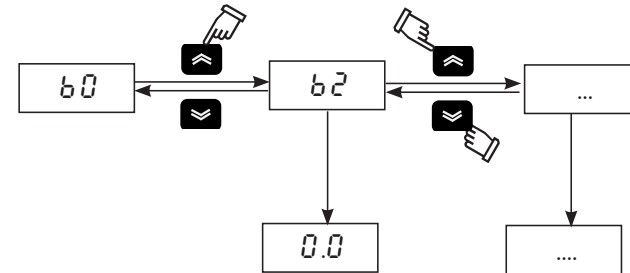

If you switch OFF the dryer with **set**, when you switch ON the sensor you chose remains memorized.

If you switch OFF the dryer with the MAIN SWITCH "⏻", when you switch ON returns to reading the B0 sensor.

5.6 Modbus ON/OFF

1. Press **set** and **esc** together at the same time to enter general menu "PAr".
2. Press **set** to enter on menu "CF9".
3. Use the arrows **⏴** or **⏵** to find parameter "A5", "CF30", "CF31", "CF32".
4. Press **set** to enter.

PARAMETER	CODE	TYPE	DEFAULT
Modbus on / off enabling	A5	D	OFF
Unit address	CF30	D	1
Baud rate	CF31	D	5
Parity	CF32	D	1

Modbus enabling

Enables the modbus function.

Unit address

Give an address to your unit.

Baud rate

1	2400	3	9600	5	38400	7	115200
2	4800	4	19200	6	57600		

Parity : 1 = EVEN; 2 = NONE; 3 = ODD

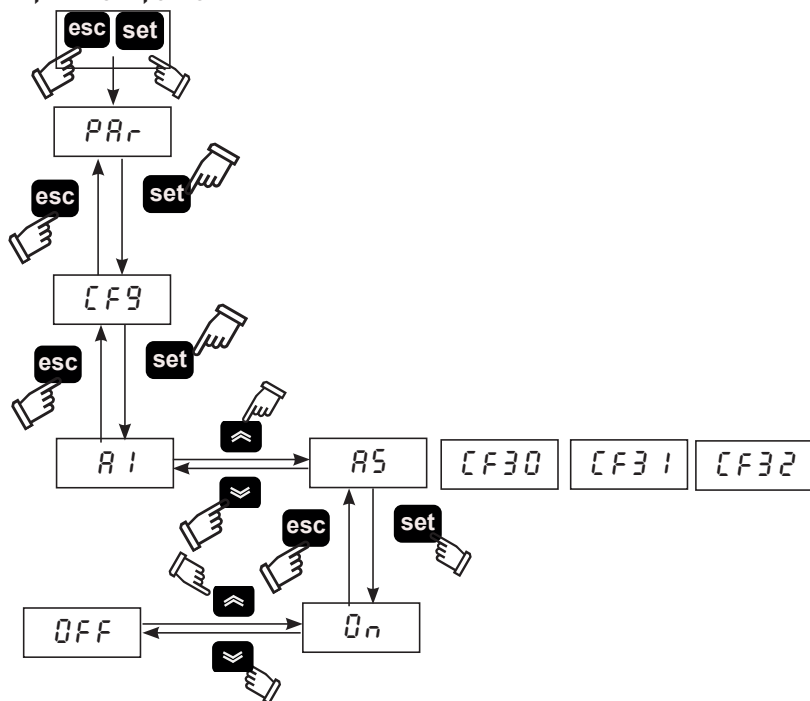

5.7 ON/OFF remoto

1. Press **set** and **esc** together at the same time to enter general menu "PAr".
2. Press **set** to enter on menu "CF9".
3. Use the arrows **⏴** or **⏵** to find parameter "A7".
4. Press **set** to enter.
5. Use the arrows **⏴** or **⏵** to choose:
ON : remote ON;
OFF: remote OFF.
6. Press **set** to confirm.
7. Press **esc** to exit.

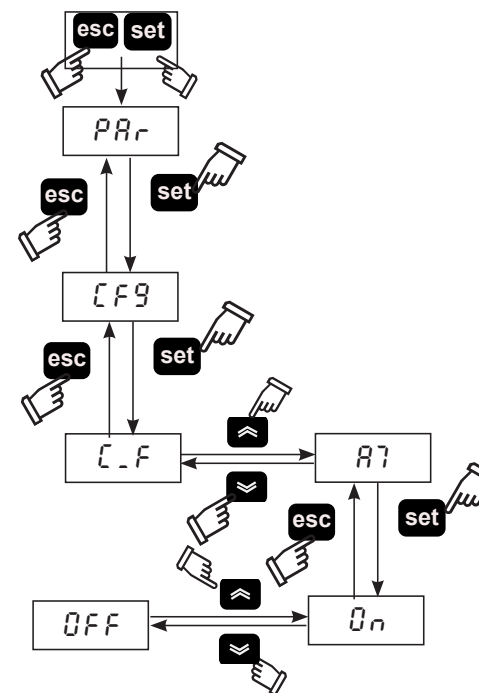

To manage REMOTE OFF mode, remove the bridge between terminals: 87 -GND and connect the remote start/stop switch (to be provided for by the customer).

5.8 CYCLING function

1. Press **set** and **esc** together at the same time to enter general menu "PAr".
2. Press **set** to enter on menu.
3. Use the arrows **⏴** or **⏵** to find parameter "C4C".
4. Press **set** to enter on menu.
5. Use the arrows **⏴** or **⏵** to find parameter "C7".
6. Press **set** to choose:
ON : continuous;
OFF: cycling.
7. Press **set** to confirm.
8. Press **esc** to exit.

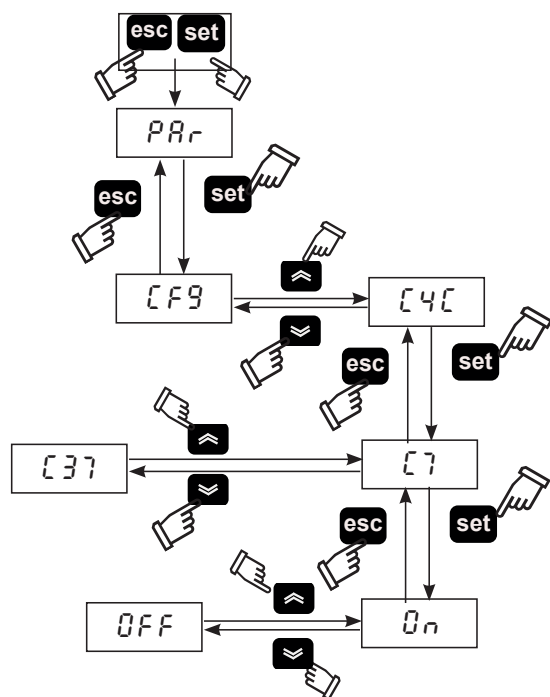

"C37" show the % of energy saving.

5.9 Alarm management

1. Press **set** and **esc** together at the same time to enter general menu "PAr".
2. Press **set** to enter on menu "CF9".
3. Use the arrows **⏴** or **⏵** to find parameter "CFJ1".

PARAMETER	CODE	TYPE	DEFAULT
Alarm relay management	CFJ1	D	OFF

OFF = alarm; On = warning /alarm

In an alarm/warning situation, follow the procedure below:

1. Press **set** to enter menu of direct parameters.
2. Use the arrows **⏴** or **⏵** to find parameter "AL".
3. Press **set** to see alarm code:

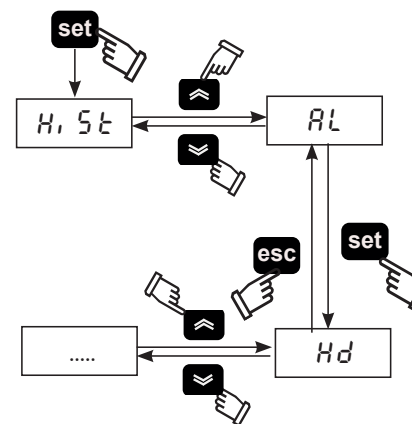

ALARM LIST				WARNING LIST			
H.C.	Cod.	Description	Reset	H.C.	Cod.	Description	Reset
10	LD	Low dew point	M	1/2	FB0/2	B0/2 sensor warning	A
11	LT	Low evaporation temperature	M	3/5	FB5/8	B5/8 sensor warning	A
13	HT2	High discharge temperature	M	7	FP1	PI sensor warning	A
18	HP	High pressure	M	24	DRE	Condensate drain warning	A
19	LP	Low Pressure	M	9	HD	High dew point warning	A
21	PI	Compressor Thermal protect.	M	12	HT1	High discharge temp.	A
22	PH	Inverted phases	M	14	HB5	High suction compres. temp.	A
				20	HP1	High pressure	A
				25	SR	Maintenance	A

(H.C=History code)

5.10 Alarm history

In an alarm/warning situation, to see the current and previous alarms occurred, follow the procedure below:

1. Press **set** to enter menu "H, St".
2. Press **set** to enter into the parameters :

Menu	Code	Description
HiSt	HiSP	Alarm position
	HiSC	Alarm code
	HiSd	Alarm date (if clock option is present)
	HiSt	Alarm hour (if clock option is present)
	HiS1/2.	value sensor

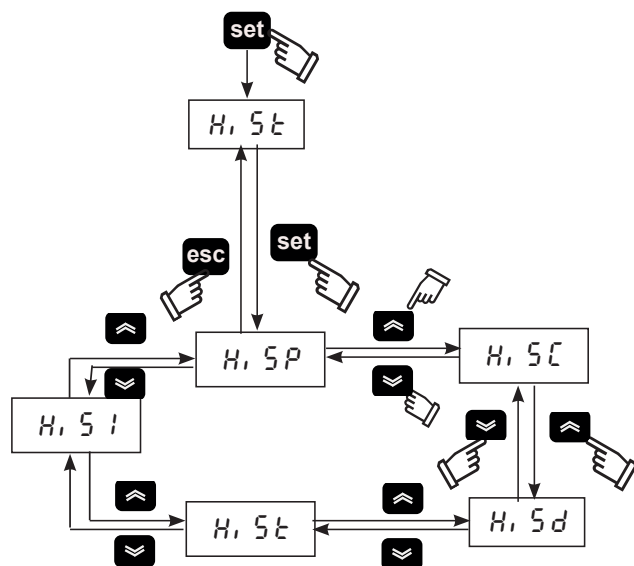

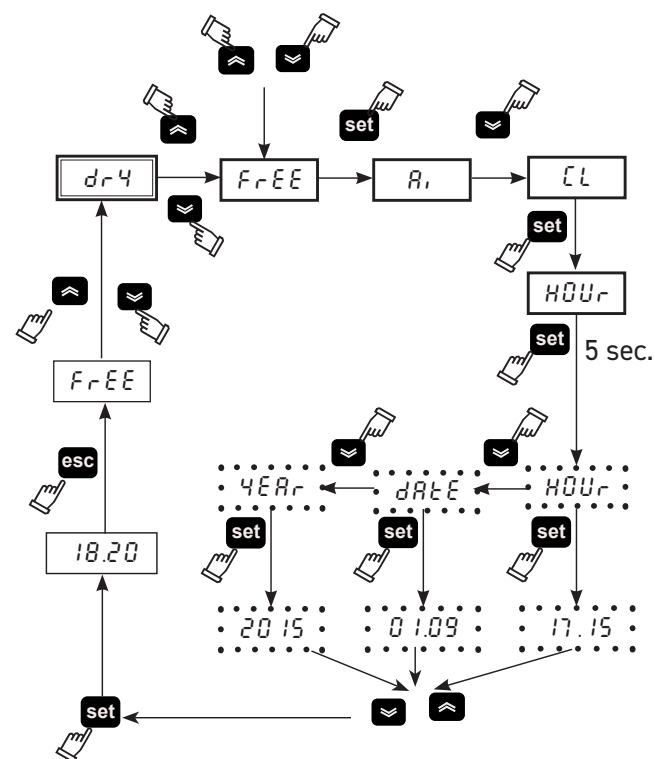

5.11 Setting clock/date

1. Press "**↑**" "**↓**", together at the same time to enter menu "FrEE".
2. Press "**set**" to enter menu "A, ".
3. Press "**↓**" to enter menu "CL".
4. Press "**set**" to enter and visualize parameter "HOUr".
5. Press "**set**" until the screen flashes "HOUr".
6. Select the flashing parameter "HOUr" / "dAtE" / "yEAR" using "**↑**" and press "**set**" to enter.
7. Change the flashing value using "**↑**" and "**↓**" (up and down) and press "**set**" to confirm.
8. Press "**esc**" to return to the menu "FrEE".
9. Press "**↑**" "**↓**" together at the same time to exit.





! The memory of the "clock / date" has a maximum duration of three days, so if the controller is left without power for more than three days, the data set hour / month / year are lost. Adjust the clock at the start up of the machine, and whenever necessary.

5.12 Software version

1. Press **set** and **esc** together at the same time to enter general menu "PAr".
2. Press **set** to enter on menu "CF9".
3. Use the arrows  or  to find parameter "UER".
4. Press **set** to see the software version.









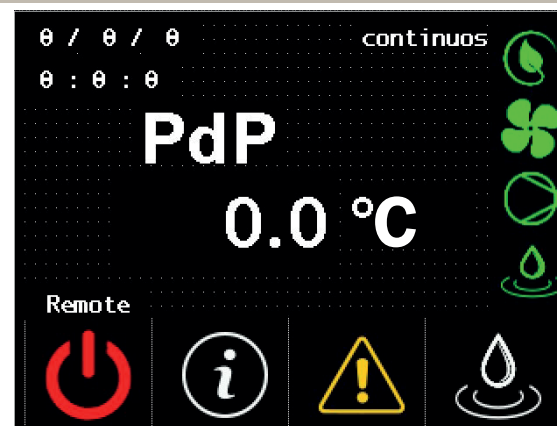



5.13 Default parameter

1. Press **set** and **esc** together at the same time to enter general menu "PAr".
2. Press **set** to enter on menu "CF9".
3. Use the arrows  or  to find parameter "dEF".
4. Press **set** to enter.
5. Change OFF to ON and press **set** to make the default.

6 Control Touch (700-1000)

6.1 Control panel "Touch"





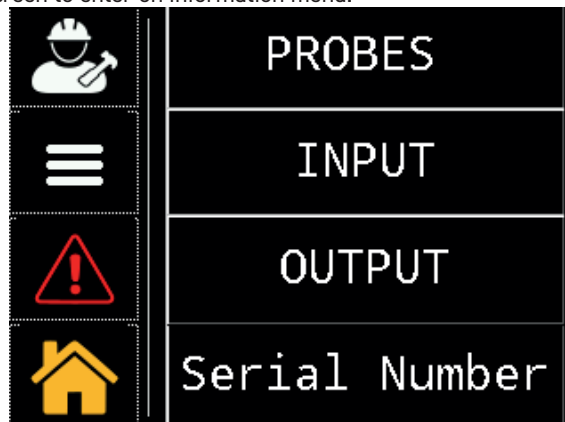

Symbol	Status symbol	Function	Symbol	Status symbol	Function
	Green	Dryer ON		Present	Present when the dryer ON, compressor OFF and without alarm (cycling)
	Red	Dryer OFF			
	-	Touch to enter on information menu		Present	Present when the fan is ON
	Red	Alarm present		Present	Present when the compressor is ON.
	Yellow	Warning present			
	Absent	No alarm/warning present			
	-	Touch to manually activate the drain		Present	Present when the drain is ON
	-	Date/Time		-	Continuous Cycling
	-	Dew point temperature		Remote Local	Remote = remote ON Local = remote OFF

6.2 Information menu

Touch  on home screen to enter on information menu.



Symbol	Function
	Touch to enter "service / Factory" menus: these menus are password protected. access is allowed only to Parker qualified or certified personnel.
	Touch to enter the "parameter settings" menu: A6, A8; °C or °F; local or remote; Drain on / off times; working hours.
	Touch to see all available alarm / warning signals.
	Touch to return to the main screen
PROBES	Touch to see the probe data : B0, B2, B3, B5, B8, P1,
INPUT	Touch to see digital input.
OUTPUT	Touch to see digital output.
Serial Number	Touch to get dryer information: serial number, software version of PLC / HMI.

6.2.1 Setting parameter date/time

Touch  to enter on menu User/service.





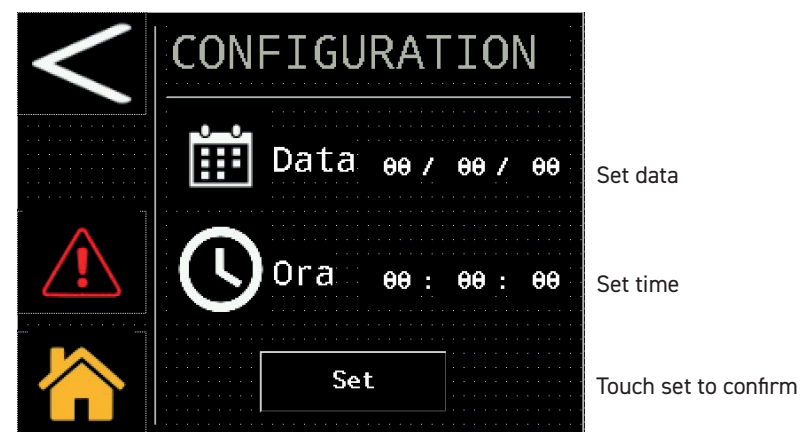



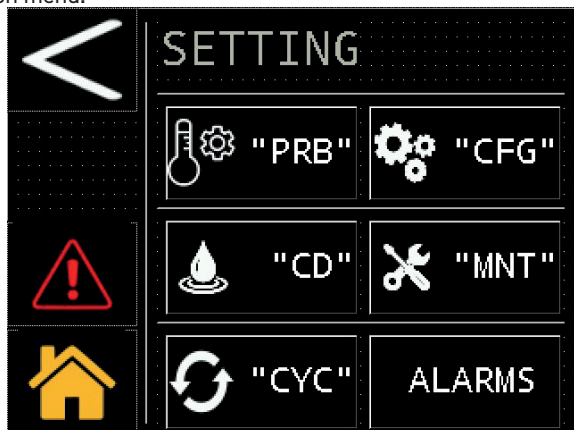

Touch  to enter on menu data/time.

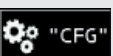

6.2.2 Setting parameter menu

Touch  to enter on menu.



Symbol	Function
	Touch to go back.
	Touch to go move forward to next screen.
	Touch to view the thresholds of the analogue output of the dew point "A6 / A8".
	Touch to configure: the unit of measure; local / remote start and alarm signaling.
	Touch to configure the drain.
	Touch to see the working hours and time of the next scheduled maintenance.
	Touch to configure the dryer.
	Touch to reset the alarm.

Sonde

Touch  "PRB" to enter.



these parameters are available for reading / writing, it is possible to change: the high dew point warning threshold and the delay. To modify the parameter, touch the value, as shown in the figure.

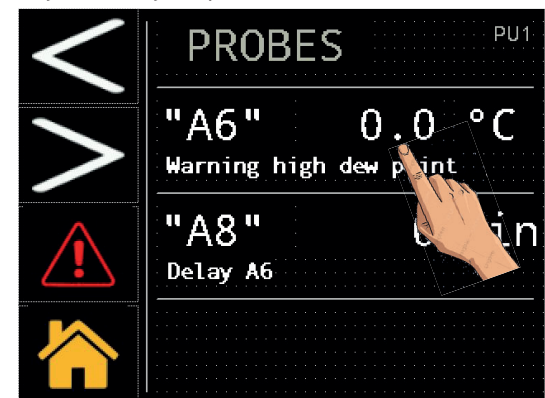

The keyboard used to dial the new desired value appears.

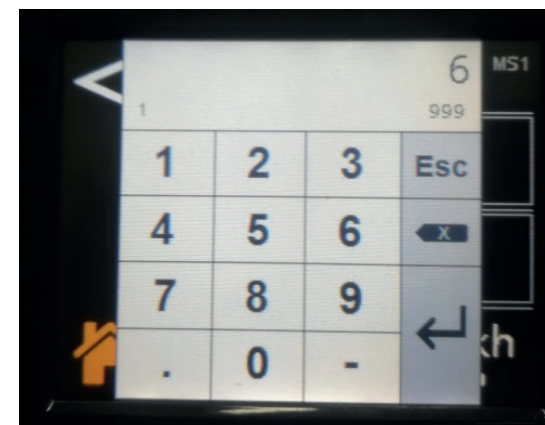

Configuration

Touch  to enter.

Unit of measure (°C or °F)

Touch the box on the right and insert the flag  to change and confirm.

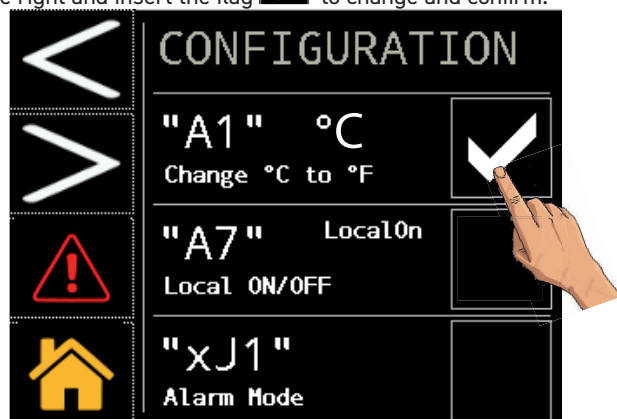

Remote control

 To manage REMOTE OFF mode, remove the bridge between terminals: 87-92 and connect the remote start/stop switch (to be provided for by the customer).

To modify parameter ("local ON or rOFF") Touch the box on the right and insert the flag  to change and confirm.

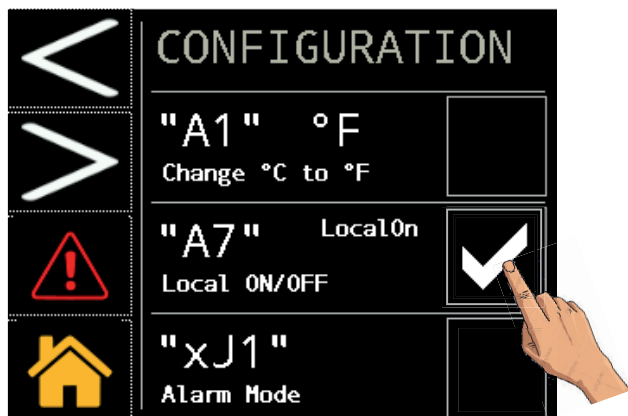

Alarm/warning

Touch the box on the right and insert the flag  to change and confirm.

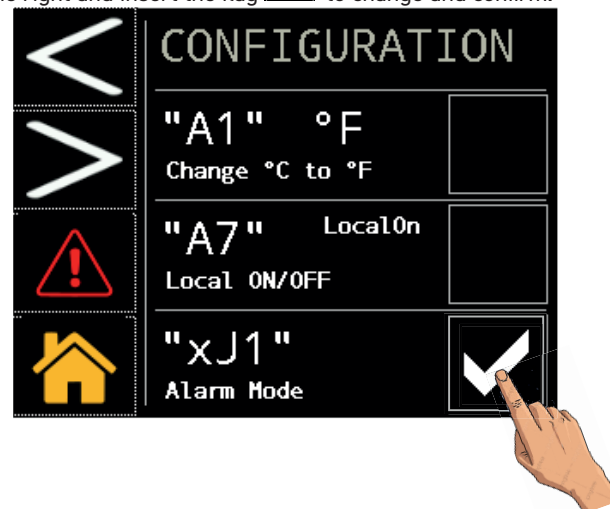

touch  to go ahead.

Default parameters

To return to the default parameters, touch as indicated in the figure.

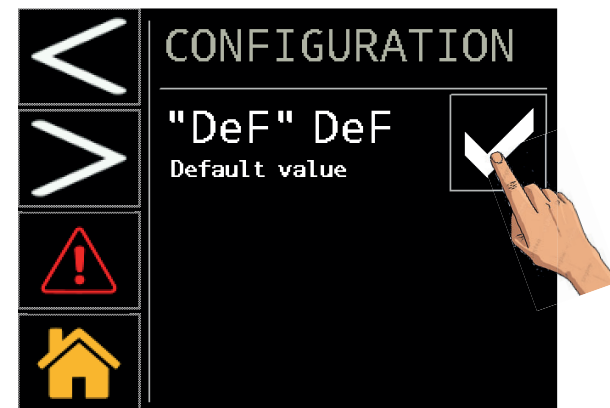

The parameters are reset automatically.

Touch  to go ahead.

Modbus

Choose your options. MODBUS RTU (RS485)

PARAMETER	Code	Default
Unit address	CF30	16
Baud rate	CF31	19200
Parity	CF32	2

Parity: 0=NONE; 1=ODD; 2=EVEN;

Baud rate			
0	9600	3	57600
1	19200	4	76800
2	38400	5	115200

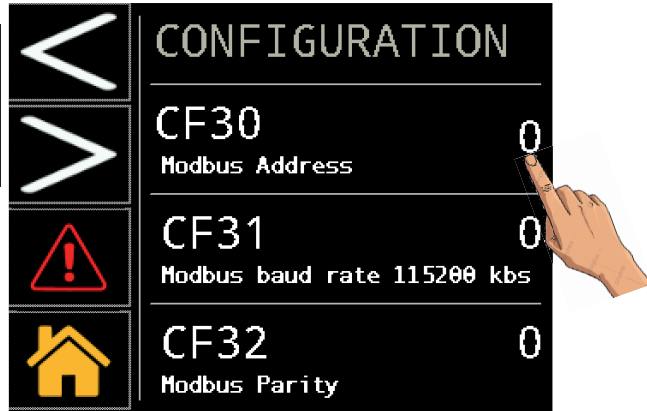

Touch  to go ahead. MODBUS TCP/IP

Choose your options.

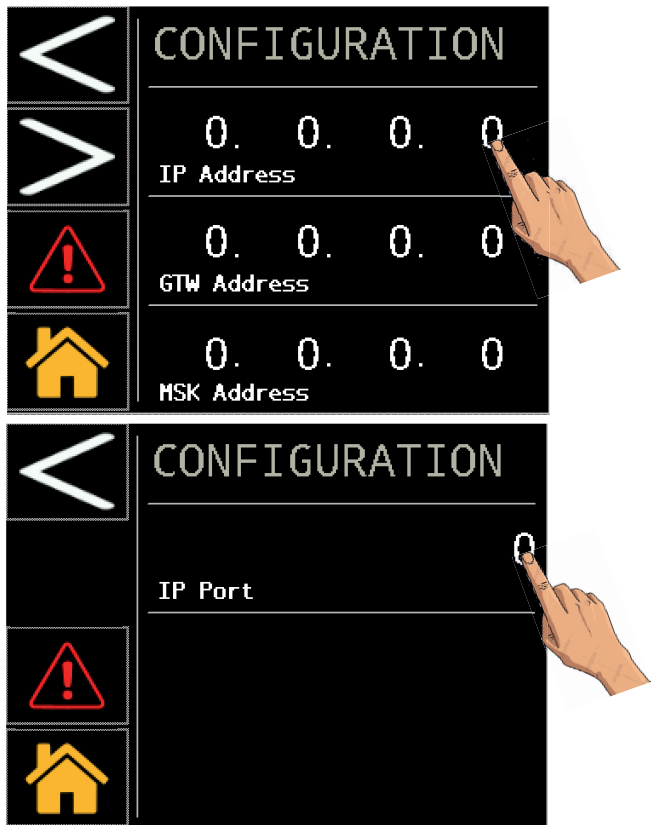

Touch  to go ahead.

Choose your options.

Switch off /switch ON the dryer to confirm

Condensate drain

Touch  to enter.

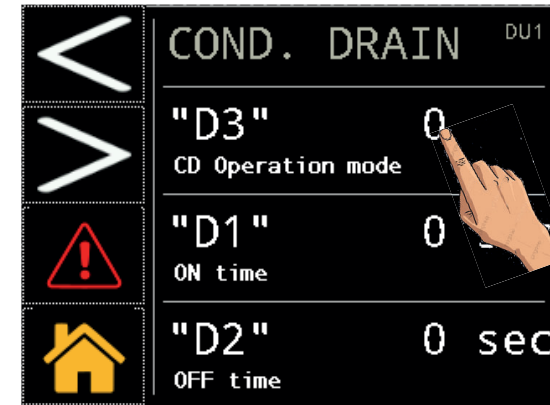

Touch as indicated to choose the type of the drain:

0 = external;

1 = timed;

2 = capacitive.

in the case of the choice of the timed discharger (1) it is also possible to choose the closing and opening times "D1 / D2".

Maintenance

Touch  to enter.

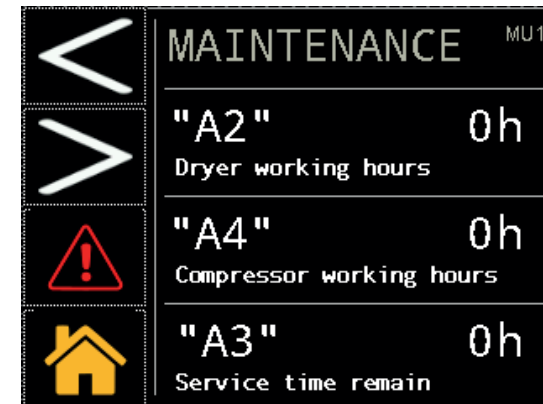



these data are read-only.

Operating "cycling"

Touch  to enter.

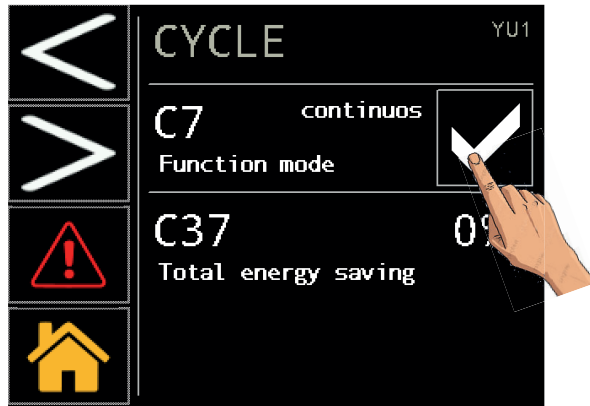
you can choose continuous or cycling mode by touching as shown in the figure.



Touch the box on the right and insert the flag  to change and confirm.

Alarm menu

Touch  to enter on menu,

To see alarms/warnings or to do the reset.



Touch  to see alarm page.

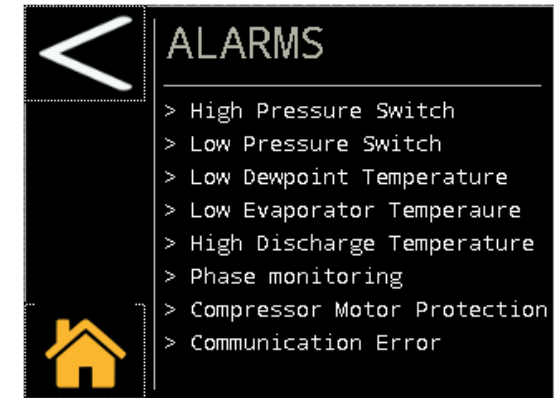

A description of the alarm appears only when an alarm is present.

Touch  to see warnings page.

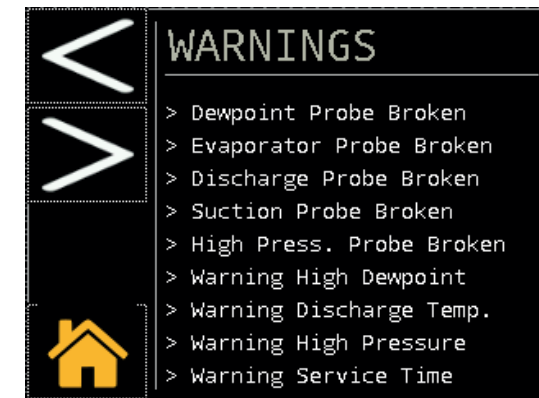

A description of the warning appears only when a warning is present.

Touch  to reset the alarm. Remember that the alarm reset can be done only if the nominal operating conditions have been restored.

6.2.3 Probe menu

Touch **PROBES** to enter.

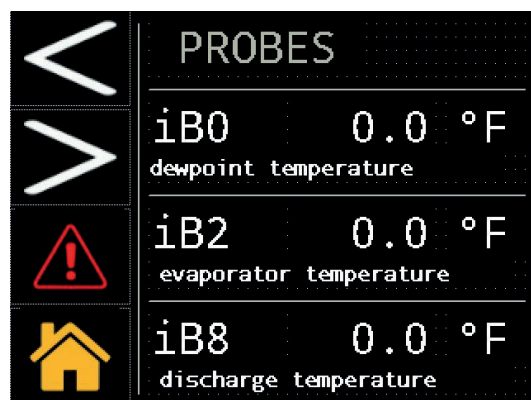

Touch  to go ahead.

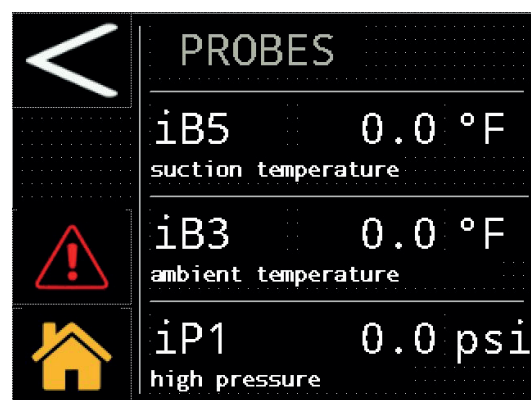

real-time probe values are displayed:

- iB0 : Dew point temperature.
- iB2 : Evaporator temperature.
- iB8 : Discharge compressor temperature.
- iB5 : Suction compressor temperature.
- iB3 : Ambient temperature.
- iP1 : High pressure (condenser).

6.2.4 Digital input menu

Touch **INPUT** to enter.

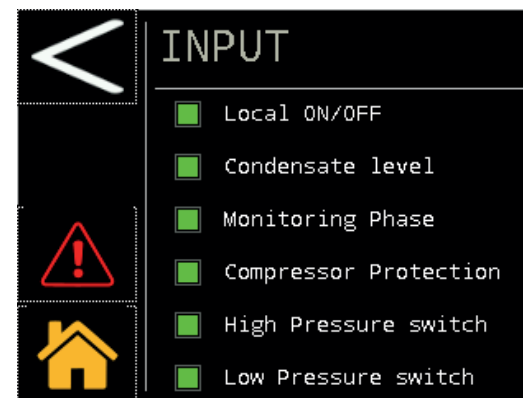
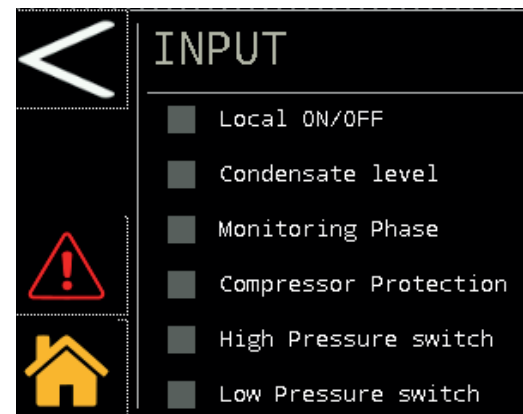

Local ON/OFF: green when remote start contact is closed, otherwise it is gray.

Condensate level: green when there is condensation to drain, otherwise it is gray.

Monitoring phase: green when phase sequence is correct, otherwise it is gray:

Compressor protection: green when compressor protection is in the normal operating position, otherwise it is gray.

High Pressure switch: green when pressure switch protection is in the normal operating position, otherwise it is gray.

Low Pressure switch: green when pressure switch protection is in the normal operating position, otherwise it is gray.

6.2.5 Digital output menu

Touch **OUTPUT** to enter.

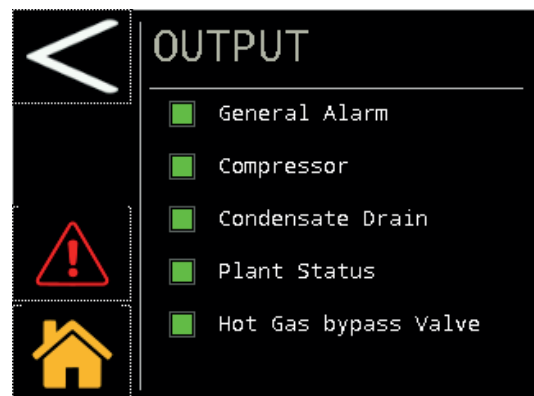
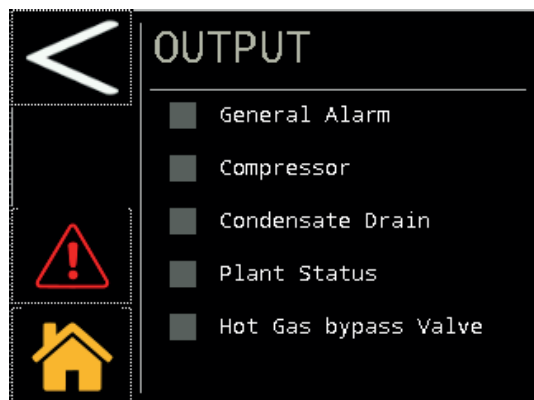

General alarm: green when general alarm contact is closed, otherwise it is gray.

Compressor: green when compressor start contact is closed, otherwise it is gray.

Condensate drain: green when condensate drain contact is closed, otherwise it is gray.

Plan Status: green when dryer on contact is closed, otherwise it is gray.

Hot gas bypass valve: green when bypass valve contact is closed (valve open), otherwise it is gray.

6.2.6 Serial number menu

Touch **Serial Number** to enter.

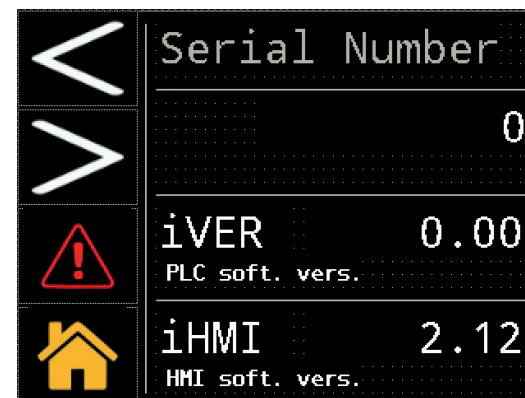

iVER: control version.

iHMI: touch version.

these data are read-only.





6.3 Rapid menu

Reach the menu in short steps:





Change Data/time

Touch  → Touch  → Touch 



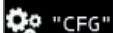

Change of measurement unit from °C to °F

Touch  → Touch  → Touch  "CFG" → Touch the box on the right and insert the flag  to change and confirm.

Change Local/rOFF

Touch  → Touch  → Touch  "CFG" → Touch the box on the right and insert the flag  to change and confirm.

Alarm/waring

Touch  → Touch  → Touch  "CFG" → Touch the box on the right and insert the flag  to change and confirm.

Default parameters

Touch  → Touch  → Touch  "CFG" → Touch  → Touch the box on the right and insert the flag  to change and confirm.





Modbus

Touch  → Touch  → Touch  "CFG" → Touch  → Touch 

View the probes

Touch  → Touch **PROBES**

Switch to cycling mode

Touch  → Touch  → Touch  "CYC" → Touch the box on the right and insert the flag  to change and confirm.

Change the drain

Touch  → Touch  → Touch  "CD" → Touch "0/1/2" to make the change.

View serial number

Touch  → Touch **Serial Number**

Alarm reset

Restore the nominal conditions.

Touch  → Touch "Reset".

Alarm history

Touch **ALARMS** → Touch  → Touch 

7 Maintenance

• The machine is designed and built to guarantee continuous operation; however, the life of its components depends on the maintenance performed.

-  When requesting assistance or spare parts, identify the machine (model and serial number) by reading the data plate located on the unit.
- Circuits containing 5t < xx < 50t of CO₂ should be checked annually to identify any potential leaks. Per European Regulation EU No. 517/2014 art. 4.3.a, 4.3.b) - Circuits containing 50t < xx < 50t of CO₂ should be checked for leaks every 6 months.
- Per European Regulation EU No. 517/2014 art. 6 - Machines containing 5t CO₂ or more, the operator must keep a written record of the quantity and type of refrigerant used, added or recovered during maintenance/repair and final disposal.

7.1 General instructions

-  Before any maintenance, make sure:
 - the pneumatic circuit is no longer pressurized;
 - the dryer is disconnected from the main power supply.

 Always use the Manufacturer's original spare parts: otherwise the Manufacturer is relieved of all liability regarding machine malfunctioning.

 In the event of refrigerant leakage, contact qualified and authorized personnel.

 The Schrader valve must only be used in case of machine malfunction: otherwise any damage caused by incorrect refrigerant charging will not be covered by the warranty.

7.2 Refrigerant















Charging: any damage caused by incorrect refrigerant replacement carried out by unauthorized personnel will not be covered by the warranty. 

 The equipment contains fluorinated greenhouse gases. At normal temperature and pressure, the R513A refrigerant is a colorless gas classified in SAFETY GROUP A1 - EN378 (group 2 fluid according to Directive PED 2014/68/EU) GWP (Global Warming Potential) = 573.

 In the event of refrigerant leakage, ventilate the room.

7.3 Preventive Maintenance Programme

To guarantee lasting maximum dryer efficiency and reliability:

Maintenance Activity Description	Maintenance Interval (standard operating conditions)				
	Daily	Weekly	4 Months	12 Months	36 Months
Activity Check  Service 					
Check POWER ON indicator is lit.					
Check control panel indicators					
Check condensate drain					
Clean condenser fins.					
Verify the correct position and operation of the crankcase heater					
Check electrical absorption					
Check refrigerant leaks					
Depressurize the dryer Complete drain maintenance					
Depressurize the dryer Replace pre- and post-filter elements					
Check temperature sensors Replace if necessary				 	
Dryer maintenance kit					



The following are available (see par. 9.4):

- 3 years preventive maintenance kits;
- service kit
 - compressor kits;
 - fan kits;
 - hot gas valve kits;
 - water condenser kits;
- individual spare parts.

7.4 Dismantling

The refrigerant and the lubricating oil contained in the circuit must be recovered in conformity with current local environmental regulations.

The refrigerant fluid is recovered before final scrapping of the equipment ((EU) No. 517/2014 art.8).

	Recycling Disposal 
structural work	steel/epoxy-polyester resins
exchanger	aluminium
pipes/headers	copper/aluminium/carbon steel
drain	polyamide
exchanger insulation	EPS (sintered polystyrene)
pipe insulation	synthetic rubber
compressor	steel/copper/aluminium/oil
condenser	copper/aluminium
refrigerant	R513A
valves	brass
electrical cables	copper/PVC

Equipment containing electrical components must be disposed separately collected with electrical and electronic waste according to local and currently legislation.



8 Troubleshooting

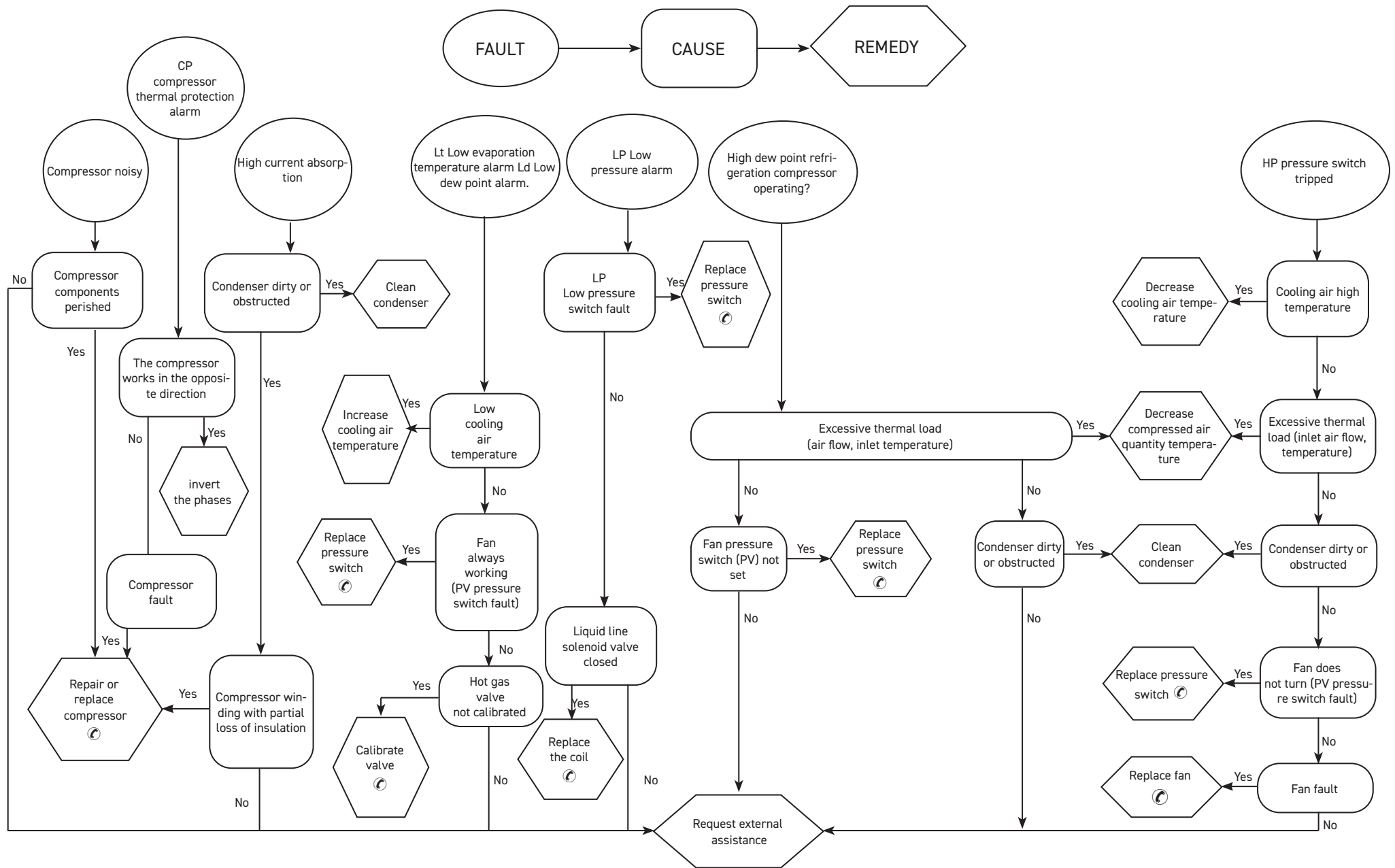

Índice

1 Seguridad	2		
1.1 Importancia del manual.....	2		
1.2 Señales de advertencia.....	2		
1.3 Instrucciones de seguridad.....	2		
1.4 Riesgos residuales.....	2		
2 Introducción	3		
2.1 Transporte.....	3		
2.2 Traslado.....	3		
2.3 Inspección.....	3		
2.4 Almacenaje.....	3		
3 Instalación	3		
3.1 Modalidades.....	3		
3.2 Espacio operativo.....	3		
3.3 Versión condensador.....	3		
3.4 Consejos.....	3		
3.5 Conexión eléctrico.....	3		
3.6 Conexión del drenaje de condensados.....	4		
4 Puesta en Marcha	4		
4.1 Comprobaciones previas.....	4		
4.2 Arranque.....	4		
4.3 Funcionamiento.....	4		
4.4 Parada.....	4		
5 Control (325-500)	5		
5.1 Panel de control.....	5		
5.2 Símbolo.....	5		
5.3 Ajuste de parámetros.....	5		
5.4 Configuración de la descarga de condensado.....	6		
5.5 Visualización de las sondas de temperatura.....	6		
5.6 Modbus ON/OFF.....	7		
5.7 ON/OFF remoto.....	7		
5.8 Función de CICLOS.....	8		
5.9 Gestión de alarmas.....	8		
5.10 Historial de alarmas.....	9		
5.11 Ajuste del reloj/calendario.....	9		
5.12 Versión de software.....	10		
5.13 Default parámetro.....	10		
6 Control (700-1000) táctil	10		
6.1 Panel de control "táctil".....	10		
6.2 Menú de información.....	11		
6.2.1 Menú Fecha/Tiempo.....	11		
6.2.2 Menú de configuración de parámetros.....	12		
6.2.3 Menú de sondas.....	16		
6.2.4 Menú de entrada digital.....	16		
6.2.5 Menú de salida digital.....	17		
6.2.6 Menú del número de serie.....	17		
6.3 Menú rápido.....	18		
7 Mantenimiento	18		
7.1 Advertencias generales.....	18		
		7.2 Refrigerante.....	18
		7.3 Programa de mantenimiento preventivo.....	19
		7.4 Desguace.....	19
		8 Solución de problemas	20
		9 Apéndice	

1 Seguridad

1.1 Importancia del manual

- Consérvelo durante toda la vida útil del equipo.
- Léalo antes de realizar cualquier operación.
- Puede sufrir modificaciones: para una información actualizada, consulte la versión instalada en el equipo.

1.2 Señales de advertencia



Instrucción para evitar peligros personales



Instrucción para evitar que se dañe el equipo





Se requiere la intervención de un técnico experto y autorizado





El significado de los símbolos utilizados se indica en el apartado 9.1

1.3 Instrucciones de seguridad

 Antes de realizar cualquier operación de mantenimiento, desconecte siempre la máquina de la red eléctrica. Utilícelo siempre durante el mantenimiento.

 El manual está destinado al usuario final y sólo para las operaciones que pueden realizarse con los paneles cerrados. Las operaciones que requieren la apertura con herramientas deben ser efectuadas por personal experto y calificado.

 No supere los límites de proyecto que se indican en la placa de características.

  El usuario debe evitar cargas distintas de la presión estática interna. En caso de riesgo de fenómenos sísmicos, es necesario proteger adecuadamente la unidad.

 Los dispositivos de seguridad en el circuito de aire comprimido están a cargo del usuario.

 Los dispositivos de seguridad del circuito del aire comprimido se dimensionan teniendo en cuenta las características técnicas del sistema y las normas locales en vigor.

La unidad debe utilizarse exclusivamente para uso profesional y con el objeto para el cual ha sido diseñada.

El usuario debe analizar todos los aspectos de la aplicación en que el producto se ha instalado, seguir todas las normas industriales de seguridad aplicables y todas las prescripciones relativas al producto descritas en el manual de uso y en la documentación redactada que se adjunta a la unidad.

La alteración o sustitución de cualquier componente por parte del personal no autorizado, así como el

uso inadecuado de la unidad eximen de toda responsabilidad al fabricante y provocan la anulación de la garantía.

El fabricante declina toda responsabilidad presente o futura por daños personales o materiales derivados de negligencia del personal, incumplimiento de las instrucciones dadas en este manual o inobservancia de las normativas vigentes sobre la seguridad de la instalación.

El fabricante no asume ninguna responsabilidad por daños debidos a alteraciones y/o modificaciones del embalaje.

El usuario es responsable que las especificaciones suministradas para seleccionar la unidad o sus componentes y/o opciones sean exhaustivas para un uso correcto o razonablemente previsible de la misma unidad o de los componentes.

 **ATENCIÓN: El fabricante se reserva el derecho de modificar sin previo aviso la información de este manual. Para que la información resulte completa, se recomienda al usuario consultar el fabricante.**

1.4 Riesgos residuales

Las operaciones de instalación, puesta en marcha, apagado y mantenimiento del equipo deben realizarse de total conformidad con lo indicado en la documentación técnica del equipo y de manera tal que no se genere ninguna situación de riesgo. Los riesgos que no han podido eliminarse con recursos técnicos de diseño se indican en la tabla siguiente

parte del equipo	riesgo residual	modo	precauciones
batería de intercambio térmico	pequeñas heridas cortantes	contacto	evitar el contacto, usar guantes de protección
rejilla del ventilador y ventilador	lesiones	introducción de objetos puntiagudos en la rejilla mientras el ventilador está funcionando	no introducir ni apoyar ningún objeto en la rejilla de los ventiladores
interior del equipo: compresor y tubo de salida	quemaduras	contacto	evitar el contacto, usar guantes de protección
interior del equipo: partes metálicas y cables eléctricos	intoxicación, electrocución, quemaduras graves	defecto de aislamiento de los cables de alimentación que llegan al cuadro eléctrico del equipo; partes metálicas en tensión	protección eléctrica adecuada de la línea de alimentación; conectar cuidadosamente a tierra las partes metálicas
exterior del equipo: zona circundante	intoxicación, quemaduras graves	incendio por cortocircuito o sobrecalentamiento de la línea de alimentación del cuadro eléctrico del equipo	sección de los cables y sistema de protección de la línea de alimentación eléctrica conformes a las normas vigentes

2 Introducción

Este manual hace referencia a los secadores frigoríficos diseñados para eliminar el vapor de agua del aire comprimido.

2.1 Transporte

El equipo embalado debe mantenerse:

- en posición vertical;
- protegido de los agentes atmosféricos;
- protegido de golpes.

2.2 Traslado

Utilice una carretilla elevadora con horquillas, adecuada para el peso del equipo, y evite todo tipo de golpes.

2.3 Inspección

- Los equipos salen de fábrica ensamblados, cableados, cargados con refrigerante y aceite, y probados en las condiciones de trabajo nominales.
- Controle el equipo a su llegada y notifique inmediatamente al transportista si nota algún inconveniente.
- Desembale el equipo lo más cerca posible del lugar de instalación.

2.4 Almacenaje

Si es necesario apilar varios equipos, respete las indicaciones impresas en el embalaje. Conserve el equipo en un lugar limpio y protegido de la humedad y la intemperie.

3 Instalación

☞ Instale en interiores en un área limpia y seca que esté protegida de los elementos, la luz solar directa y / u otras condiciones adversas.

⚠ El producto instalado debe estar adecuadamente protegido contra el riesgo de incendio (ref. EN378-3).

3.1 Modalidades

☞ Respete las indicaciones dadas en los apartados 9.2 y 9.3.

Todos los secadores deben contar con una adecuada prefiltración instalada cerca de la entrada de aire del secador. El vendedor no tendrá ninguna responsabilidad ni obligación de compensación por daño directo o indirecto causado por la ausencia de prefiltración adecuada

☞ El elemento de prefiltro (para filtración de 3 micrones o mejor) debe ser sustituido al menos una vez al año o antes, según las recomendaciones del fabricante.

☞ Conecte correctamente el secador utilizando las bocas de entrada y salida del aire comprimido.

3.2 Espacio operativo

☞ Deje un espacio libre de 1.5 m todo alrededor del equipo.

En los modelos con expulsión vertical del aire de condensación, deje 2 m libres sobre el secador.

3.3 Versión condensador

Versión por aire (Ac)

No cree situaciones que permitan la recirculación del aire de enfriamiento.

No obstruya las rejillas de ventilación.

Versión por agua (Wc)

Si el suministro no lo incluye, instale un filtro de malla en la entrada del agua de condensación.

☞ Características del agua de condensación utilizada

Temperatura	≥50°F (10°C)	CL ⁻	<50 ppm
ΔT IN/OUT	5-15°C	CaCO ₃	70-150 ppm
Max % de glicol	50	O ₂	<0.1 ppm
Presión	43.5-145 PSIG (3-10 barg)	Fe	<0.2 ppm
PH	7.5-9	NO ₃	<2 ppm
Conductividad eléctrica	10-500 μS/cm	HCO ₃ ⁻	70-300 ppm
Índice de saturación de Langelier	0-1	H ₂ S	<0.05 ppm
SO ₄ ²⁻	<50 ppm	CO ₂	<5 ppm
NH ₃	<1 ppm	Al	<0.2 ppm

Es posible que los materiales estándar previstos para el condensador no sean adecuados para determinadas aguas de refrigeración (desionizada, desmineralizada, destilada). En estos casos, se ruega ponerse en contacto con el fabricante.

3.4 Consejos

A fin de proteger los componentes internos del secador y del compresor de aire, no instale el equipo donde el aire circundante contenga contaminantes sólidos o gaseosos, en particular azufre, amoníaco y cloro. Evite también la instalación en ambiente marino.

En las versiones con ventiladores axiales, se desaconseja canalizar el aire agotado.

3.5 Conexión eléctrico

Utilice un cable homologado con arreglo a las reglamentaciones locales (para la sección mínima del cable, vea el apartado 9.3).

Instale un interruptor magnetotérmico diferencial aguas arriba del equipo (RCCB - IDn = 0,3 A) con distancia 3 mm entre los contactos cuando el interruptor está abierto (consulte las disposiciones locales al respecto).

La corriente nominal "In" de dicho magnetotérmico debe ser igual a FLA y la curva di intervención de tipo D.

Seleccione la fuente de alimentación e inserte un puente como se muestra a continuación:

S7-S6 por 400/3/50

S8-S6 por 460/3/60

Dentro del cuadro eléctrico hay una etiqueta de instrucciones.

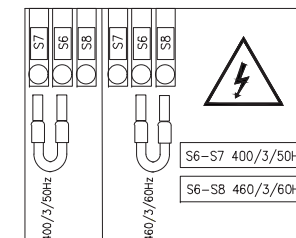

3.6 Conexión del drenaje de condensados

☞ Para conectar el equipo al sistema de drenaje, evite la conexión en circuito cerrado en común con otras líneas de descarga presurizadas. Compruebe que los condensados fluyan correctamente. Deseche los condensados con arreglo a las normas medioambientales vigentes.

4 Puesta en Marcha

4.1 Comprobaciones previas

Antes de poner en marcha el secador, asegúrese de que:

- la instalación haya sido realizada de acuerdo con lo expuesto en la sección 3;
- las válvulas de entrada del aire están cerradas y no hay flujo de aire en el secador;
- el suministro eléctrico es correcto;
- con la versión Wc, abra el circuito de agua de refrigeración durante unos minutos antes de encender el secador.

4.2 Arranque



1. Encienda la alimentación girando el INTERRUPTOR PRINCIPAL "  " a "I ON":
(para el modelo 0325-0500) hay una etiqueta debajo del control para informar que:

☞ **LA RESISTENCIA DEL CÁRTER DEBE ACTIVARSE 12 HORAS ANTES DE PONER EN MARCHA EL SECADOR.**

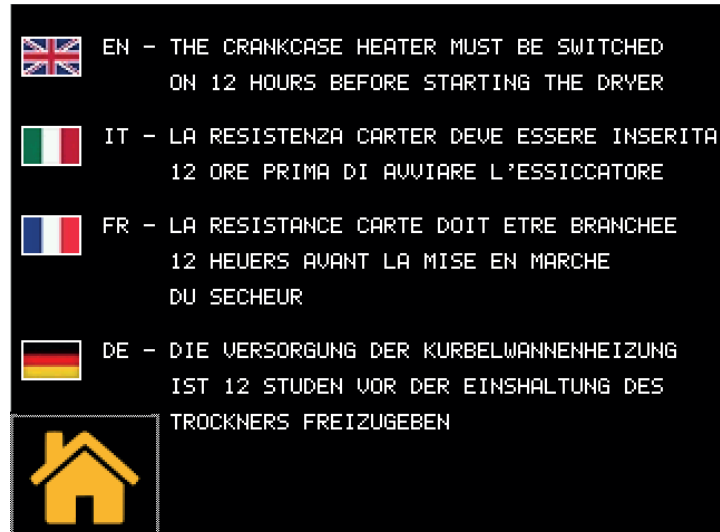
(para el modelo 0700-1000) aparecen en la pantalla:



Pulse  por volver al panel de control.

2. Pulse  para arrancar (modelo 325-500)
Pulse  para arrancar (modelo 700-1000).

3. Encienda el secador antes que el compresor de aire;

☞ Ventilador (versión Ac): si está conectado con la secuencia de fase incorrecta, girarán en dirección opuesta con riesgo de dañarse (en este caso el aire saldrá del armario del secador por las rejillas del condensador en vez de la rejilla del ventilador - consulte el párr. 9.8 para el flujo de aire correcto); invierta inmediatamente las dos fases.

4. Espere 5 minutos y después abra lentamente la válvula de entrada de aire;
5. abra lentamente la válvula de salida de aire: ahora el secador está secando.



Monitor de fase

Si aparece una alarma en la pantalla durante el arranque del secador, el usuario deberá revisar el cableado de los terminales de entrada del interruptor de desconexión del secador.

4.3 Funcionamiento

- Deje el secador en marcha durante todo el periodo de funcionamiento del compresor de aire;
- El secador funciona en modo automático, por lo tanto, no es necesario realizar ajustes en el lugar de trabajo;
- En caso de producirse flujos de aire excesivos e inesperados, haga una derivación para no sobrecargar el secador.
- Evite las fluctuaciones de temperatura en el aire de entrada.

4.4 Parada





1. Detenga el secador 2 minutos después de que se detenga el compresor de aire o, en todo caso, después de la interrupción del flujo de aire;
2. asegúrese de que el aire comprimido no entra en el secador cuando este se encuentre desconectado o si ocurre una alarma.
3. Pulse  para detener el secador (modelo 325-500)
Pulse  para detener el secador (modelo 700-1000).
4. Gire el INTERRUPTOR PRINCIPAL "  " "O OFF" para desconectar la alimentación.

☞ Versión Wc: cierre el circuito de agua con el secador apagado.









5 Control (325-500)

5.1 Panel de control











-  Botón ARRIBA: púlselo para incrementar el valor de un parámetro editable seleccionado
PULSADO DURANTE 3s. Arrancar descarga de condensado manual.
-  Botón ABAJO: púlselo para reducir el valor de un parámetro editable seleccionado.
-  Botón ESC: para salir sin guardar; volver al nivel anterior;
PULSADO DURANTE 5 s. RESTABLECER ALARMA.
-  Botón SET: para salir y guardar/confirmar el valor; ir al siguiente nivel; acceder al menú de ajustes;
PULSADO DURANTE 5 s. ARRANCAR secador.
-  : pulsarlos juntos para acceder a los parámetros del programa

5.2 Símbolo

Símbolo	Estado del símbolo	Función	Símbolo	Estado del símbolo	Función
	Encendido	compresor ACT		Encendido	secador ACT Compresor DES
	Apagada	compresor DES		Encendido	
	Encendido	secador ACT		Encendido	grados
	Destellante	secador DES		Encendido	
	Encendido	Alarma presente		Encendido	
	Destellante	Advertencia presente			
	Apagada	No hay una alarma presente			
	Encendido	Descarga de condensado ACT			
	Apagada	Descarga de condensado DES			

5.3 Ajuste de parámetros

Unidad de medida de temperatura

1. Cómo ajustar la unidad de medida de temperatura.
2. Pulse simultáneamente  y  para acceder al menú general "PAr".
3. Pulse  para acceder al menú "CF9".
4. Pulse  para elegir:
5. Utilice las flechas  o  para encontrar el menú "R1".
6. Pulse  para elegir: ON = Fahrenheit (PSI) / OFF = Celsius(bar).
7. Pulse  para confirmar.
8. Pulse  para salir.

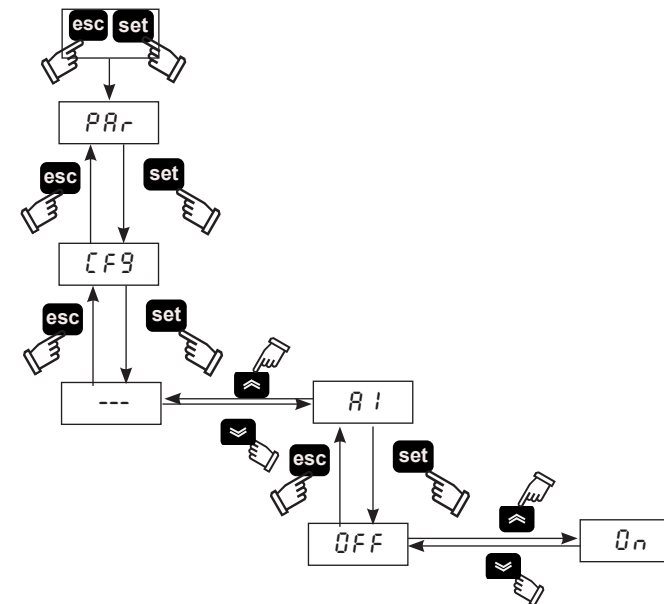

5.4 Configuración de la descarga de condensado

Hay tres modos de funcionamiento:

- CAPACITIVO = Descarga automática con un sensor capacitivo;
- TEMPORIZADO = Intervalos de descarga programables;
- CONTINUO (externo) = Si hay una descarga externa.

1. Pulse simultáneamente **set** y **esc** para acceder al menú general "PAr".
2. Pulse **set** para acceder
3. Utilice las flechas **⏴** o **⏵** para encontrar el menú "Cd".
4. Pulse **set** para acceder.
5. Utilice las flechas **⏴** o **⏵** para encontrar el menú "d3".
6. Pulse **set** para elegir el tipo de descarga:
0 = externa;
1 = temporizada;
2 = capacitiva.
7. Pulse **set** durante cinco segundos para seleccionar la descarga.

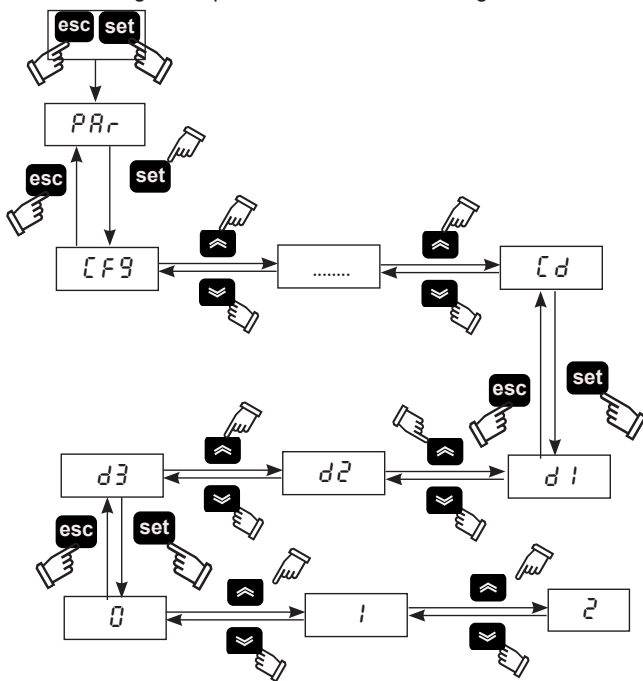

Para la opción (1) de descarga temporizada, se puede ajustar el tiempo ON/OFF de la descarga. En el menú "Cd".

1. Utilice las flechas **⏴** o **⏵** para encontrar el parámetro "d1" y elegir la hora de apertura.

2. Pulse **set** para confirmar.
3. Utilice las flechas **⏴** o **⏵** para encontrar el parámetro "d2" y elegir la hora de cierre.
4. Pulse **set** para confirmar.
5. Pulse **esc** para salir.

5.5 Visualización de las sondas de temperatura

En la pantalla, aparece la temperatura del punto de condensación de forma predeterminada. Para ver otras temperaturas, proceda como sigue:

- Utilice las flechas **⏴** o **⏵** para elegir el sensor.
- b0 = sensor de temperatura del punto de condensación;
 - b2 = sensor de temperatura de evaporación;
 - b5 = sensor de temperatura de aspiración del compresor
 - b8 = sensor de temperatura de condensado;
 - P1 = sensor de Alta presión

Después de seleccionar, espere unos segundos para ver el valor leído.

6. Pulse **esc** para salir.

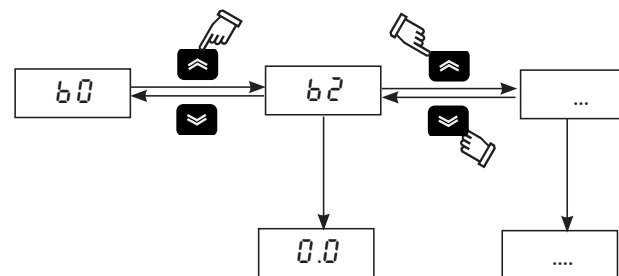

Si apaga la secadora con **set**, al encender el sensor que eligió permanece memorizado.

Si apaga la secadora con el INTERRUPTOR PRINCIPAL "⏻", al encender vuelve a leer el sensor B0.

5.6 Modbus ON/OFF

1. Pulse simultáneamente **set** y **esc** para acceder al menú general "PAr".
2. Pulse **set** para acceder al menú "CF9".
3. Utilice las flechas **⏴** o **⏵** para encontrar el parámetro "A5", "CF30", "CF31", "CF32".
4. Pulse **set** para acceder.

PARÁMETRO	CÓDIGO	TIPO	DEFAULT
Activación on / off modbus	A5	D	OFF
Dirección de unidad	CF30	D	1
Baud rate	CF31	D	5
Parity	CF32	D	1

Activación Modbus

Habilita la función modbus

Baud rate

1	2400	3	9600	5	38400	7	115200
2	4800	4	19200	6	57600		

Parity : 1 = EVEN; 2 = NONE; 3 = ODD

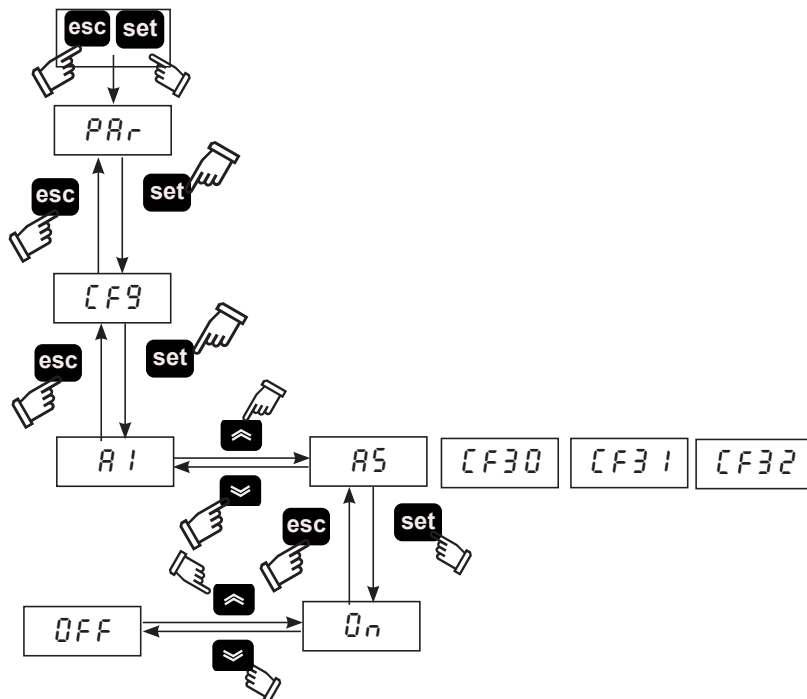

dirección de la unidad

Dar una dirección a su unidad

5.7 ON/OFF remoto

1. Pulse simultáneamente **set** y **esc** para acceder al menú general "PAr".
2. Pulse **set** para acceder al menú "CF9".
3. Utilice las flechas **⏴** o **⏵** para encontrar el parámetro "A7".
4. Pulse **set** para acceder.
5. Utilice las flechas **⏴** o **⏵** para seleccionar:
ON: encendido remoto;
OFF: apagado remoto.
6. Pulse **set** para confirmar.
7. Pulse **esc** para salir.

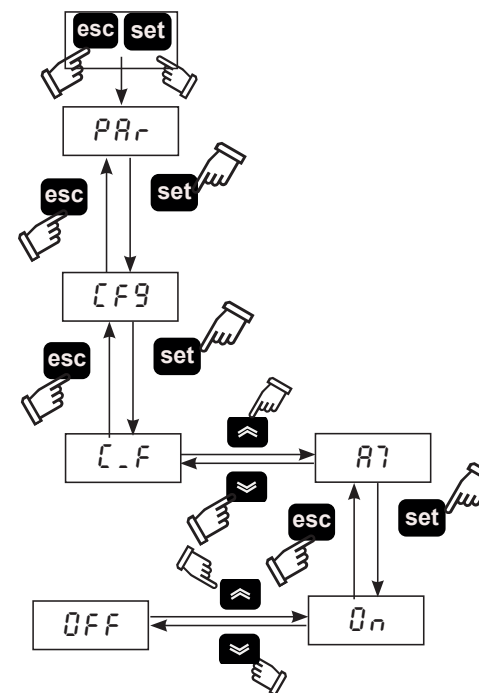

☞ Para gestionar el modo REMOTE OFF, quitar el puente entre los terminales: 87 -GND y conectar el interruptor de arranque/parada remoto (a cargo del cliente).

5.8 Función de CICLOS

1. Pulse simultáneamente **set** y **esc** para acceder al menú general "PAr".
2. Pulse **set** para acceder.
3. Utilice las flechas **⏴** o **⏵** para encontrar el parámetro "C4C".
4. Pulse **set** para acceder.
5. Utilice las flechas **⏴** o **⏵** para encontrar el parámetro "C7".

Press **set** para elegir:

ON : continuo

OFF: en ciclos

6. Pulse **set** para confirmar.
7. Pulse **esc** para salir.

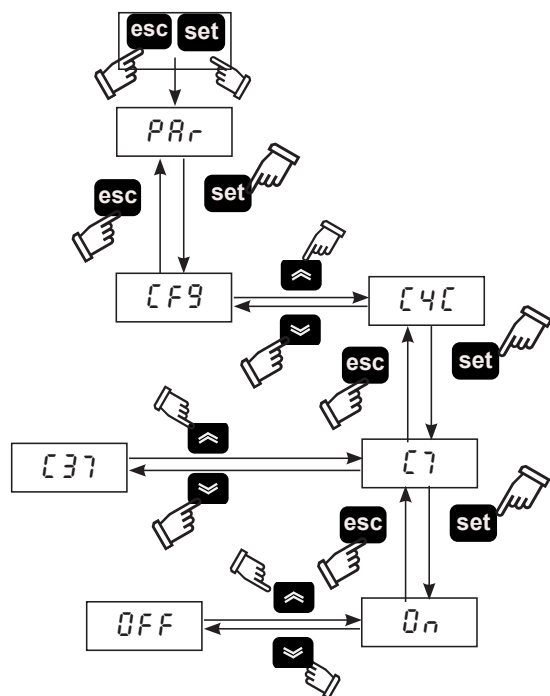

"C37" mostrar el % de ahorro de energía.

5.9 Gestión de alarmas

1. Pulse simultáneamente **set** y **esc** para acceder al menú general "PAr".
2. Pulse **set** para acceder al menú "CF9".
3. Utilice las flechas **⏴** o **⏵** para encontrar el parámetro "CFJ1".

PARÁMETRO	CÓDIGO	TIPO	DEFAULT
Gestión de alarmas	CFJ1	D	OFF

OFF = solo alarma; On = Advertencia /alarma

En una situación con alarmas/advertencias, siga este procedimiento:

1. Pulse **set** para acceder al menú de parámetros directos.
2. Utilice las flechas **⏴** o **⏵** para encontrar el parámetro "AL".
3. Pulse **set** para ver el código de la alarma:

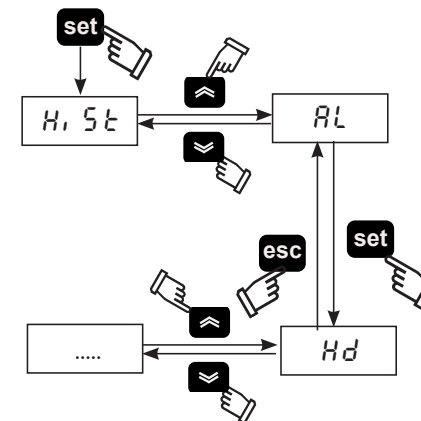

Lista de alarmas				Lista de advertencias			
H.C.	Cod.	Descripción	Reset	H.C.	Cod.	Descripción	Reset
10	LD	Punto de condensación bajo	M	1/2	FB0/2	Advertencia sensor B0/B2	A
11	LT	Temp. de evaporación baja	M	3/5	FB5/8	Advertencia sensor B5/B8	A
13	HT2	Temp. de descarga alta	M	7	FP1	Advertencia del sensor PI	A
18	HP	Alta presión	M	24	DRE	Advertencia de descarga de condensado	A
19	LP	Baja presión	M	9	HD	Advertencia de temperatura de condensado alta	A
21	PI	Protección térmica del compr.	M	12	HT1	Temperatura de descarga alta	A
22	PH	Fases invertidas	M	14	HB5	Temp. de aspiración compr. alta	A
				20	HP1	Alta presión	A
				25	SR	Mantenimiento	A

(H.C.=History cod.)

5.10 Historial de alarmas

En una situación con alarmas/advertencias, siga este procedimiento para ver las alarmas actuales y anteriores que han ocurrido:

1. Pulse **set** para acceder al menú "H, St".
2. Pulse **set** para acceder a los parámetros:

Menú	Código	Descripción
HiSt	HiSP	Posición de la alarma
	HiSC	Código de alarma
	HiSd	Fecha de la alarma (con la opción de reloj presente)
	HiSt	Hora de la alarma (con la opción de reloj presente)
	HiS1/2.	valor del sensor

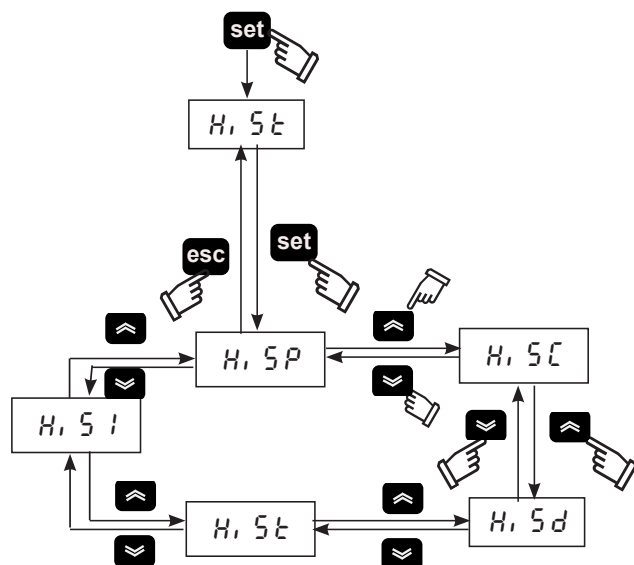

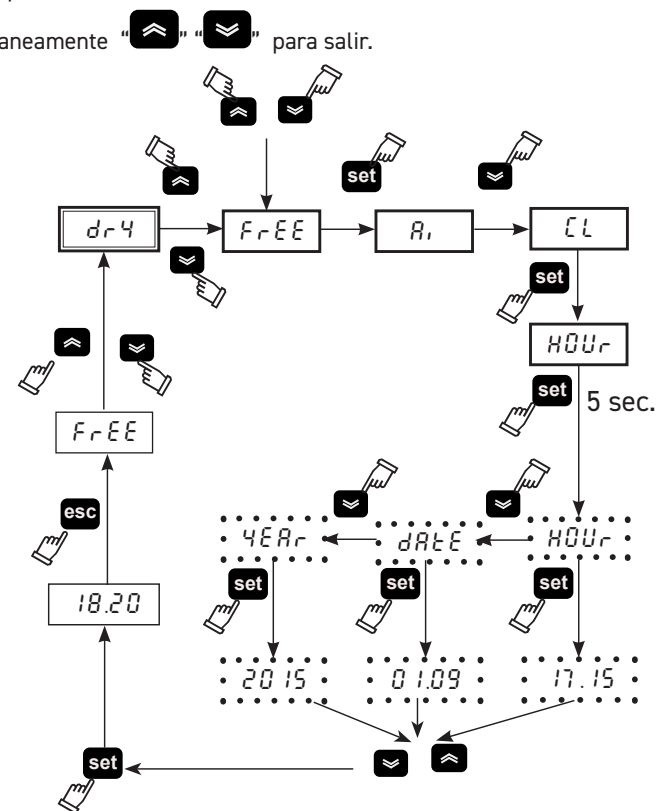

5.11 Ajuste del reloj/calendario.

1. Pulse simultáneamente "⏪" "⏩", para acceder al menú "FrEE".
2. Pulse **set** para acceder al menú "A, ".
3. Pulse "⏩" para acceder al menú "CL".
4. Pulse **set** para acceder a los parámetros "HOUr".
5. Pulse **set** hasta que destelle el parámetro "HOUr".
6. Seleccione el parámetro destellante "HOUr" / "dAtE" / "4ERr" using "⏪" y pulse **set** para acceder.
7. Cambie el valor que destella con "⏪" y "⏩" (arriba y abajo), y pulse **set** para confirmar.
8. Pulse **esc** para volver al menú "FrEE".
9. Pulse simultáneamente "⏪" "⏩" para salir.





! La memoria del "reloj / calendario" tiene una duración máxima de tres días, por lo que si el controlador no recibe alimentación eléctrica durante más de tres días, se perderán los datos de hora / mes / año. Ajuste el reloj cuando empiece a utilizar el dispositivo y siempre que sea necesario.

5.12 Versión de software

1. Pulse simultáneamente **set** y **esc** para acceder al menú general "PAr".
2. Pulse **set** para acceder al menú "CF9".
3. Utilice las flechas  o  para encontrar el parámetro "UER".
4. Pulse **set** para ver la versión del software.









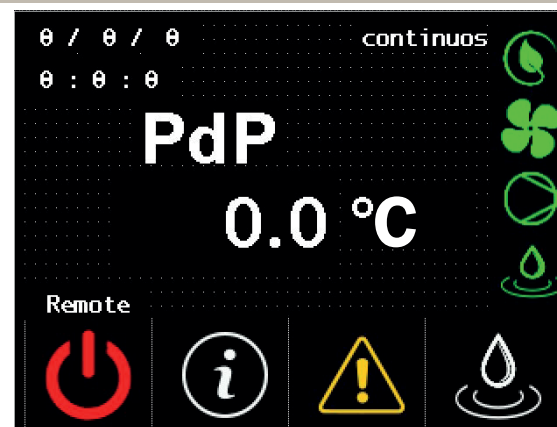

5.13 Default parámetro

1. Pulse simultáneamente **set** y **esc** para acceder al menú general "PAr".
2. Pulse **set** para acceder al menú "CF9".
3. Utilice las flechas  o  para encontrar el parámetro "DEF".
4. Pulse **set** para acceder.
5. Cambie de APAGADO a ENCENDIDO y presione **set** para establecer el valor predeterminado.

6 Control (700-1000) táctil

6.1 Panel de control "táctil"





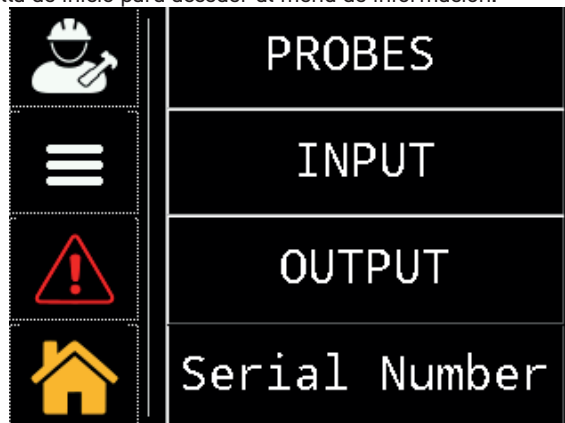

Símbolo	Símbolo de estado	Función	Símbolo	Símbolo de estado	Función
	Green	secador ACT		Present	Se ilumina con el secador encendido, el compresor apagado y sin alarmas (por ciclos)
	Red	secador DES			
	-	Toque para acceder al menú de información		Present	Se ilumina cuando el ventilador está encendido.
	Red	Alarma presente		Present	Se ilumina cuando el compresor está encendido.
	Yellow	Advertencia presente			
	Absent	No hay una alarma/ advertencia presente			
	-	Toque para activar manualmente la descarga		Present	Se ilumina cuando la descarga está encendida.
	-	Fecha/Tiempo		-	Continuo Ciclos
	-	Temperatura de punto de condensación		Remote Local	Remote = remote ON Local = remote OFF

6.2 Menú de información

Toque  en la pantalla de inicio para acceder al menú de información.



Símbolo	Función
	Toque para acceder a los menús "Servicio / Fábrica": estos menús están protegidos por contraseña. El acceso solo se permite al servicio técnico de Parker o a personal certificado.
	Toque para acceder al menú de "configuración de parámetros": A6, A8; °C o °F; local o remoto; horas de encendido / apagado de la descarga; horas de funcionamiento.
	Toque para ver todas los signos de alarmas / advertencias disponibles.
	Toque para volver a la Pantalla principal
PROBES	Toque para ver las sondas: B0, B2, B5, B8, P1.
INPUT	Toque para ver la entrada digital.
OUTPUT	Toque para ver la salida digital.
Serial Number	Toque para obtener información sobre el secador: número de serie, versión de software del PLC / HMI.

6.2.1 Menú Fecha/Tiempo

Toque  para acceder al menú de "User/service".





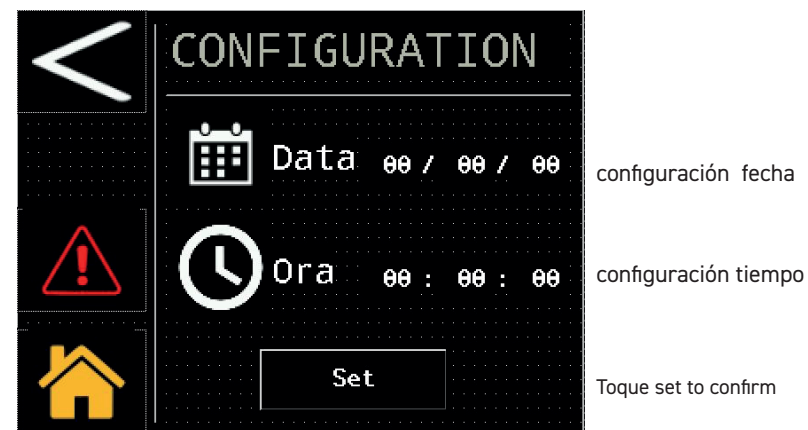



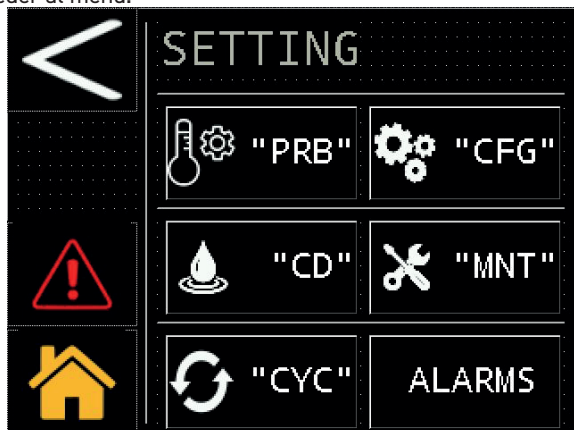

Toque  para acceder al menú de "fecha/tiempo".



6.2.2 Menú de configuración de parámetros

Toque  para acceder al menú.



Símbolo	Función
	Toque para retroceder
	Toque para avanzar
	Toque para ver los umbrales de la salida analógica del punto de condensación "A6 / A8".
	Toque para configurar: unidades de medida; arranque local / remoto y señalización de alarmas.
	Toque para configurar la descarga.
	Toque para ver las horas de funcionamiento y la fecha del siguiente mantenimiento programado.
	Toque para configurar el secador.
	Toque para reiniciar la alarma.

Sondas

Toque  para acceder.

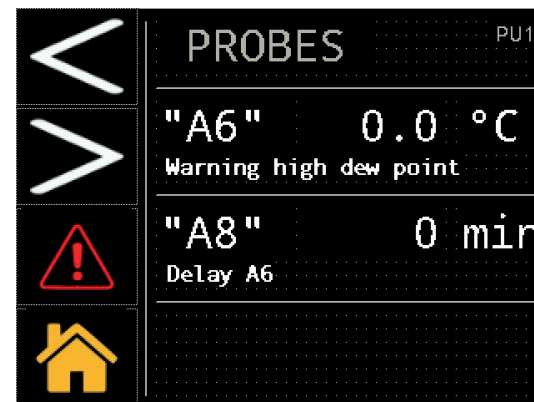

Estos parámetros son de lectura / escritura, es posible cambiar: el umbral de advertencia del punto de condensación alto y el retraso. Para modificar el parámetro, toque en el valor, como se muestra en la figura.

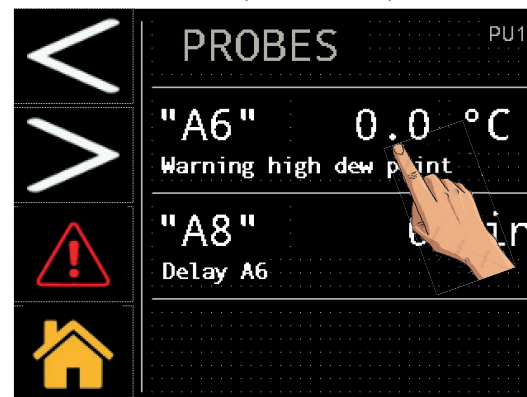

Aparece el teclado que se utiliza para introducir el nuevo valor.

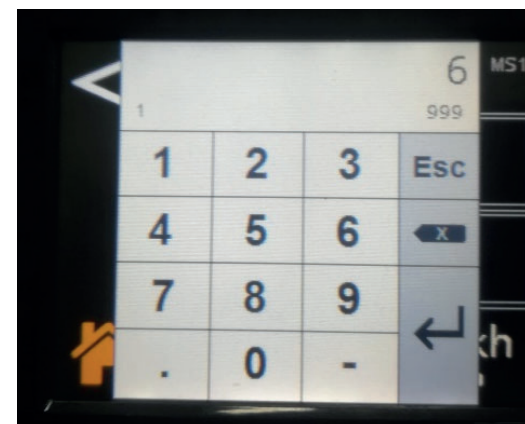

Configurazione

Toque  "CFG" para acceder.

Unidad de medida (°C o °F)

Toque en el cuadro de la derecha e inserte la marca  para confirmar y cambiar.

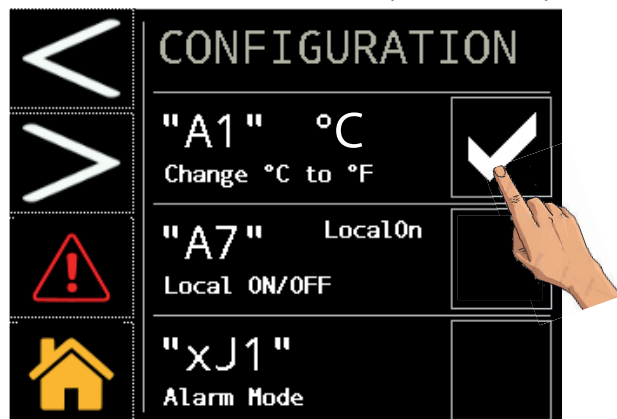

Arranque local o remoto

 Para administrar el modo REMOTE OFF, retire el puente entre los terminales: 87-92 y conecte el interruptor de arranque / parada remoto (a ser proporcionado por el cliente).

Para modificar el parámetro Toque en el cuadro de la derecha e inserte la marca  para confirmar y cambiar.

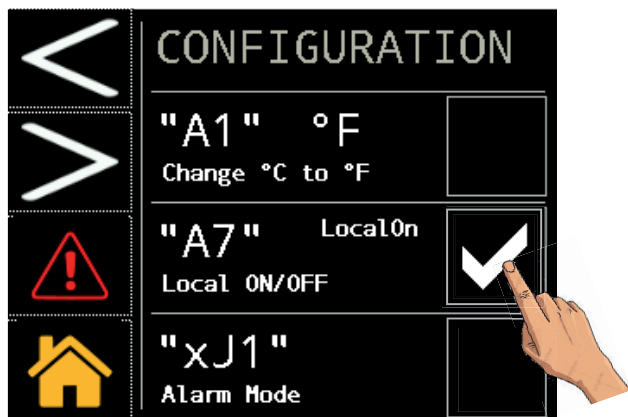

Alarmas/ advertencia

Toque en el cuadro de la derecha e inserte la marca  para confirmar y cambiar.

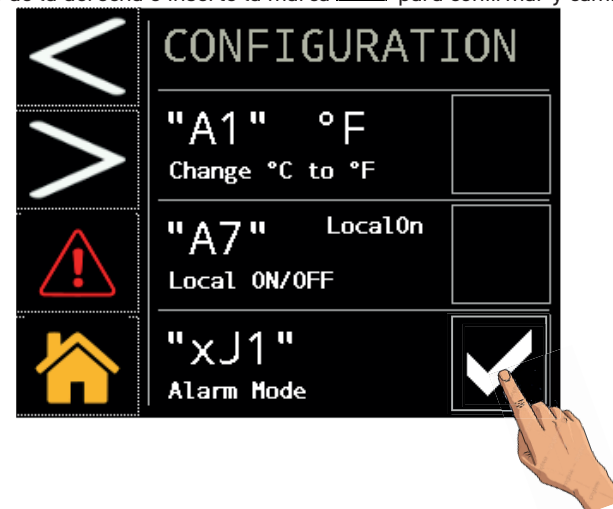

Toque  para avanzar.

Parámetros predeterminados

Para volver a los parámetros predeterminados, toque como se indica en la figura.

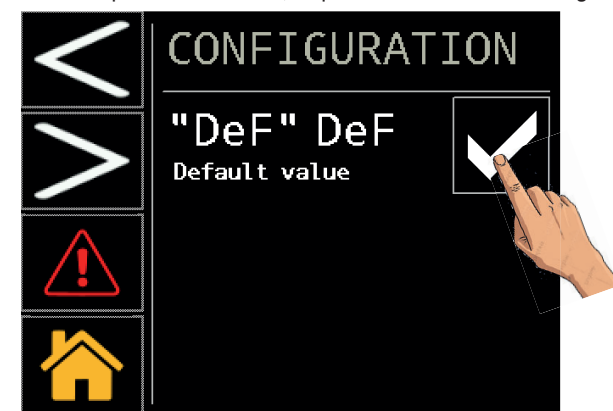

Los parámetros se restablecen automáticamente.

Toque  para avanzar.

Modbus

Seleccione sus opciones. MODBUS RTU (RS485)

PARÁMETRO	Cod.	Default
Unit address	CF30	16
Baud rate	CF31	19200
Parity	CF32	2

Parity: 0=NONE; 1=ODD; 2=EVEN;

Baud rate			
0	9600	3	57600
1	19200	4	76800
2	38400	5	115200

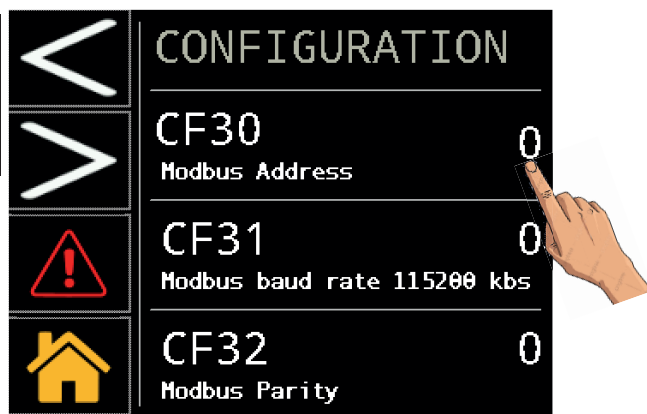

Toque  para avanzar. MODBUS TCP/IP

Seleccione sus opciones.

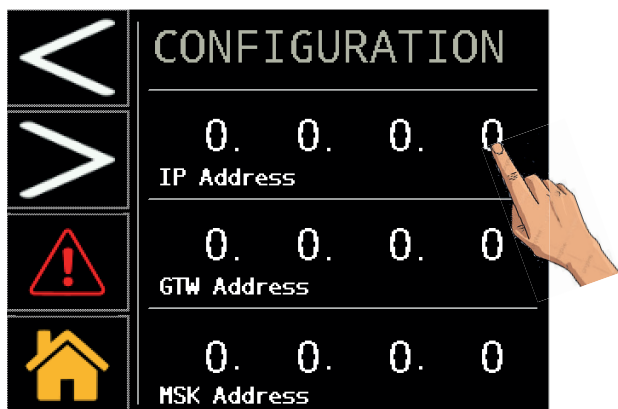

Toque  para avanzar.

Seleccione sus opciones.

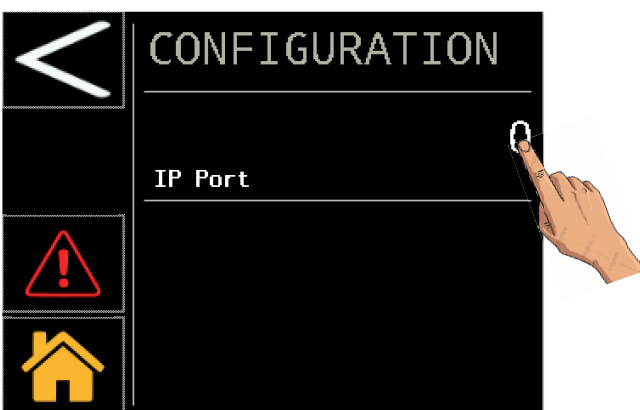

Detener/enciender el secador para confirmar.

Descarga

Toque  para acceder.

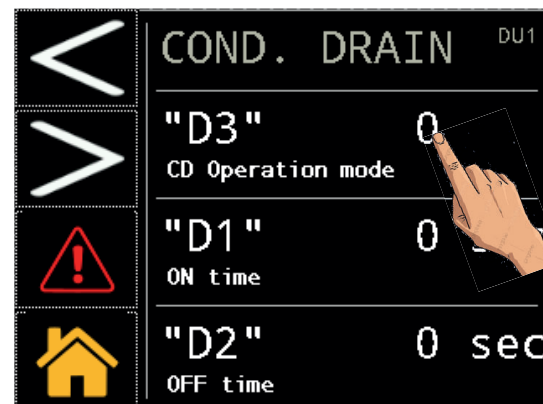

Pulse como se indica para elegir el tipo de descarga:

- 0 = externa;
- 1 = temporizada;
- 2 = capacitiva.

En el caso de la opción de descarga temporizada (1) también es posible elegir las horas de cierre y apertura "D1 / D2".

Mantenimiento

Toque  para acceder.

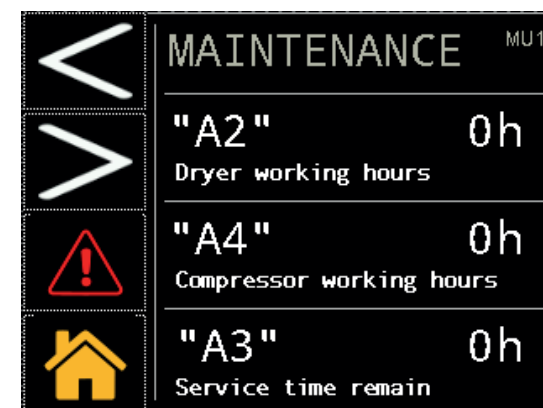

Estos datos son de solo lectura.

Funcionamiento "por ciclos"

Toque  para acceder.

Puede elegir el modo continuo o por ciclos si toca como se muestra en la figura.

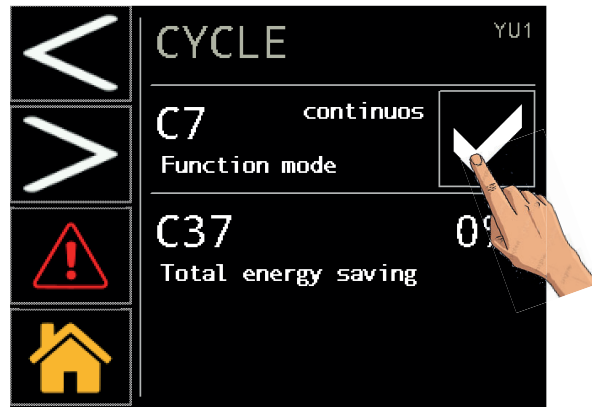

Toque en el cuadro de la derecha e inserte la marca  para confirmar y cambiar.

Menú de alarmas

Toque  para acceder al menú.

Para ver las alarmas/advertencias o restablecerlas.



Toque  para ver la página de alarmas.

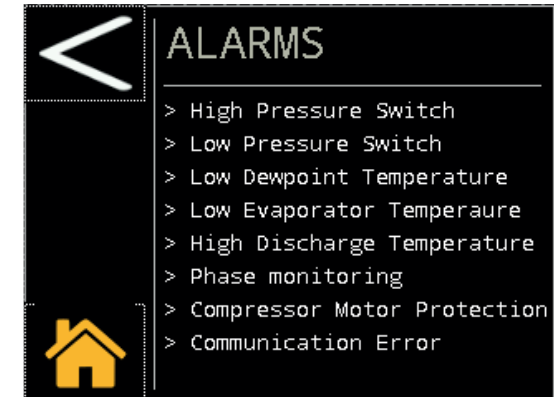

El texto con la descripción solo aparece si hay una alarma presente.

Toque  para ver la página de advertencias.

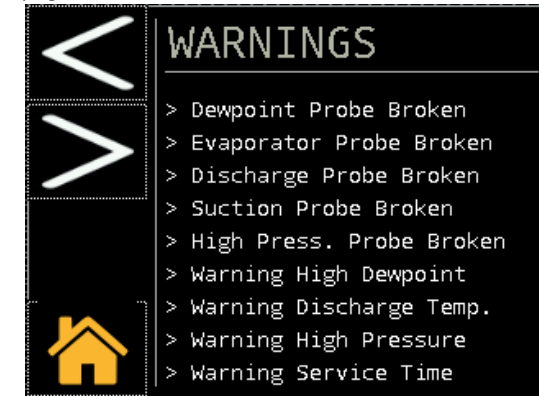

El texto con la descripción solo aparece si hay una advertencia presente.

Toque  para reiniciar la alarma. Recuerde que la alarma se puede restablecer solo si se han restaurado las condiciones de funcionamiento nominales.

6.2.3 Menú de sondas

Toque **PROBES** para acceder.

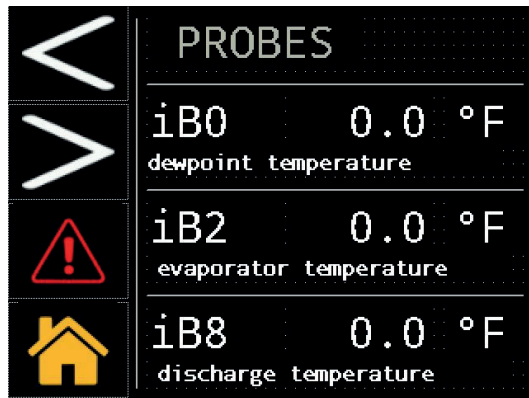

Toque **>** para avanzar.

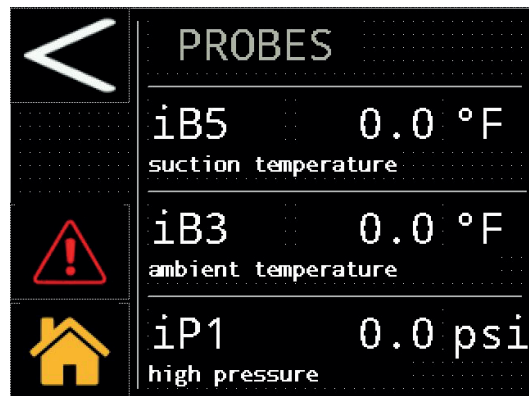

Se muestran los valores de las sondas en tiempo real:

- iB0 : Temperatura de punto de condensación.
- iB2 : Temperatura de evaporador.
- iB8 : Temperatura de descarga del compresor.
- iB5 : Temperatura de aspiración del compresor.
- iB3 : Temperatura ambiente.
- iP1 : Alta presión (condensador).

6.2.4 Menú de entrada digital

Toque **INPUT** para acceder.

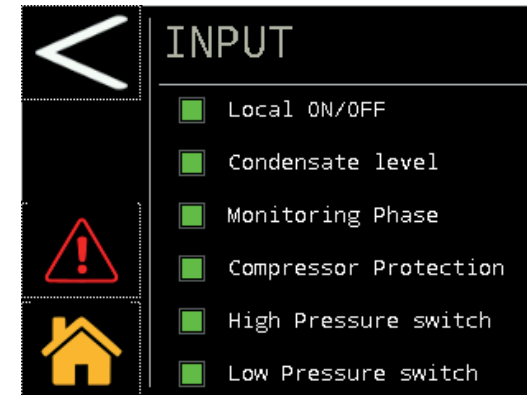
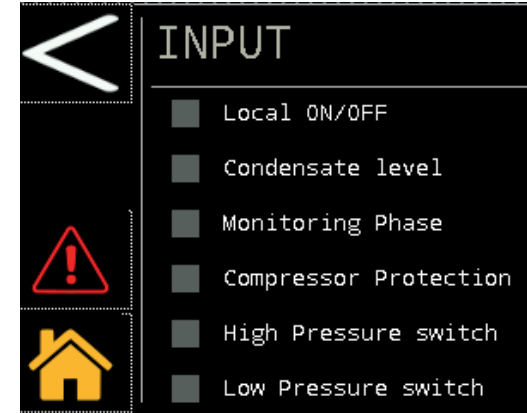

Local ON/OFF (Act./Des. local): verde si el contacto de encendido remoto está cerrado; de lo contrario, atenuado.

Condensate level (Nivel de condensado): verde si no hay condensado que descargar; de lo contrario, atenuado.

Monitoring phase (Fase de monitorización): verde si la secuencia de fase es correcta; de lo contrario, atenuado.

Compressor protection (Protección del compresor): verde si la protección del compresor está en la posición de funcionamiento normal; de lo contrario, atenuado.

High Pressure switch (Conmutador alta presión): verde si la protección del conmutador de presión está en la posición de funcionamiento normal; de lo contrario, atenuado.

Low Pressure switch (Conmutador baja presión): verde si la protección del conmutador de presión está en la posición de funcionamiento normal; de lo contrario, atenuado.

6.2.5 Menú de salida digital

Toque **OUTPUT** para acceder.

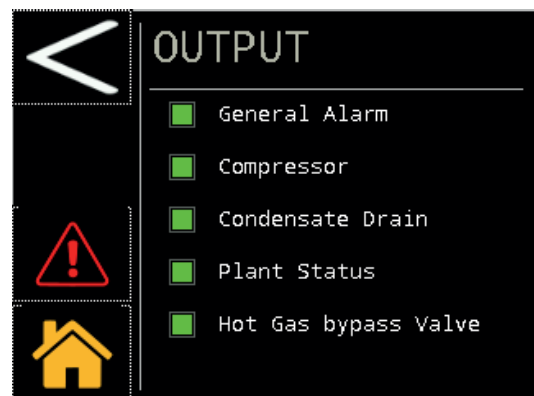
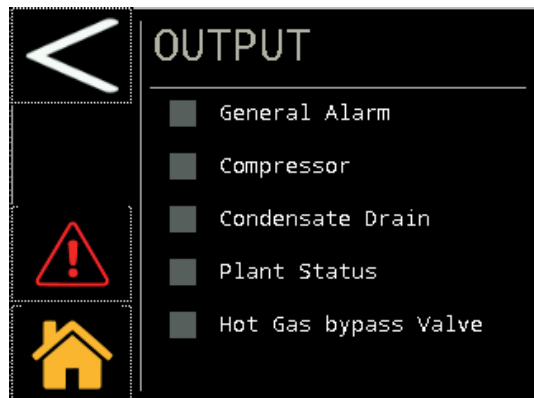

General alarm (Alarma general): verde si el contacto de alarma general está cerrado; de lo contrario, atenuado.

Compressor (Compresor): verde si el contacto de encendido del compresor está cerrado; de lo contrario, atenuado.

Condensate drain (Descarga de condensado): verde si el contacto de descarga de condensado está cerrado; de lo contrario, atenuado.

Plant Status (Estado de planta): verde si el contacto de encendido del secador está cerrado; de lo contrario, atenuado.

Hot gas bypass valve (Válvula de derivación del gas caliente): verde si el contacto de la válvula de derivación está cerrado (válvula abierta); de lo contrario, atenuado.

6.2.6 Menú del número de serie

Toque **Serial Number** para acceder al menú.

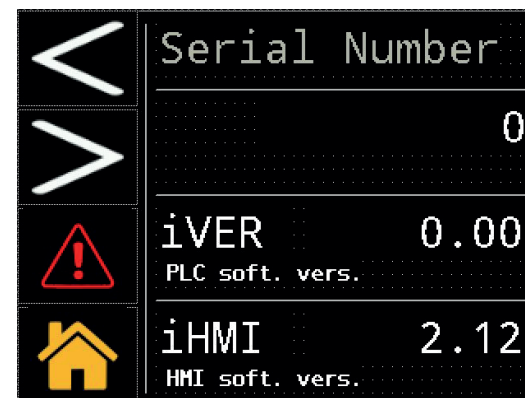

iVER: versión control.

iHMI: versión táctil.

Estos datos son de solo lectura.





6.3 Menú rápido

Acceda al menú mediante pasos rápidos:



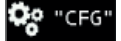

Change Data/time

Toque  → Toque  → Toque 



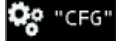

Change of measurement unit from °C to °F

Toque  → Toque  → Toque  → Toque en el cuadro de la derecha e inserte la marca  para confirmar y cambiar.



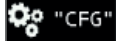

Change Local/rOFF

Toque  → Toque  → Toque  → Toque en el cuadro de la derecha e inserte la marca  para confirmar y cambiar.

Change Localon/rOFF

Toque  → Toque  → Toque  → Toque en el cuadro de la derecha e inserte la marca  para confirmar y cambiar.

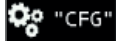
Default parameters

Toque  → Toque  → Toque  → Toque  → Toque en el cuadro de la derecha e inserte la marca  para confirmar y cambiar.





Modbus

Toque  → Toque  → Toque  → Toque  → Toque 

View the probes

Toque  → Toque **PROBES**

Switch to cycling mode

Toque  → Toque  → Toque  → Toque en el cuadro de la derecha e inserte la marca  para confirmar y cambiar.

Change the drain

Toque  → Toque  → Toque  → Toque "0/1/2" para realizar el cambio.

View serial number

Toque  → Toque **Serial Number**

Alarm reset

Restore the nominal conditions.

Toque  → Toque "Reset"

Alarm history

Toque **ALARMS** → Toque  → Toque 

7 Mantenimiento

• El aparato ha sido diseñado y fabricado para garantizar un funcionamiento continuo; No obstante, la vida útil de sus componentes depende del mantenimiento que se realice.

•  Cuando pida ayuda o piezas sueltas, identifique el aparato (modelo y número de serie) leyendo la placa de datos ubicada en la máquina.

7.1 Advertencias generales

 Antes de realizar cualquier operación de mantenimiento, compruebe que:

- el circuito neumático no esté a presión,
- el secador esté desconectado de la red eléctrica.

 El uso de repuestos no originales exime al fabricante de toda responsabilidad por el mal funcionamiento del equipo.

 En caso de pérdida de refrigerante, llame a un técnico experto y autorizado.

 La válvula Schrader debe utilizarse sólo en caso de funcionamiento anómalo del equipo; de lo contrario, los daños causados por una carga incorrecta de refrigerante no serán reconocidos en garantía.

7.2 Refrigerante

Operación de carga: los daños causados por una carga del refrigerante incorrecta realizada por personal no autorizado no serán reconocidos en garantía. 















 El aparato contiene gases fluorados de efecto invernadero.

El fluido refrigerante R513A, a temperatura y presión normales, es un gas incoloro perteneciente al SAFETY GROUP A1 - EN378 (fluido del grupo 2 según la directiva PED 2014/68/UE); GWP (Global Warming Potential) = 573..

 En caso de fuga de refrigerante, airee el local.

7.3 Programa de mantenimiento preventivo

Per garantire nel tempo la massima efficienza ed affidabilità dell'essiccatore eseguire:



Acciones de mantenimiento	Intervalo de tiempo (condiciones de funcionamiento estándar)				
	Diarias	Semanales	4 Meses	12 Meses	36 Meses
<p>Acciones</p> <p>comprobar  actuar </p>					
Comprobar que el indicador POWER ON está encendido.					
Comprobar todos los indicadores del panel de control.					
Comprobar el purgador.					
Limpiar el condensador, rejilla y conexiones.					
Comprobar que la posición/ operación de la resistencia del cárter sea correcta					
Comprobar el consumo eléctrico.					
Comprobar las pérdidas de refrigerante.					
Despresurizar la instalación. Hacer mantenimiento integral del purgador.					
Despresurizar la instalación. Sustituir todos los elementos filtrantes de los filtros instalados.					
Comprobar las sondas de temperatura. Sustituir si fuera necesario.				 	
Conjunto de mantenimiento del secador.					

Están disponibles (apartado 9.4):

- kits de mantenimiento preventivo de los 3 años;
- kits de servicio
 - kits compresor
 - kits ventilador
 - kits de válvula gas caliente
 - Kits de condensador de agua
- piezas de repuesto individuales.

7.4 Desguace

El fluido refrigerante y el aceite lubricante contenidos en el circuito deben recogerse de conformidad con las normas locales.

	Reciclaje Desecho 
estructura	acero/resinas epoxi-poliéster
intercambiador	aluminio
tuberías/colectores	cobre/aluminio/acero al carbono
drenaje condensados	polyamide
aislamiento intercambiador	EPS (poliestireno sinterizado)
aislamiento tuberías	caucho sintético
compresor	acero/cobre/aluminio/aceite
condensador	cobre/aluminio
refrigerante	R513A
válvulas	latón
cables eléctricos	cobre/PVC

Los equipos que contengan componentes eléctricos deben eliminarse por separado junto con los residuos eléctricos y electrónicos de acuerdo con la legislación local y vigente.



8 Solución de problemas

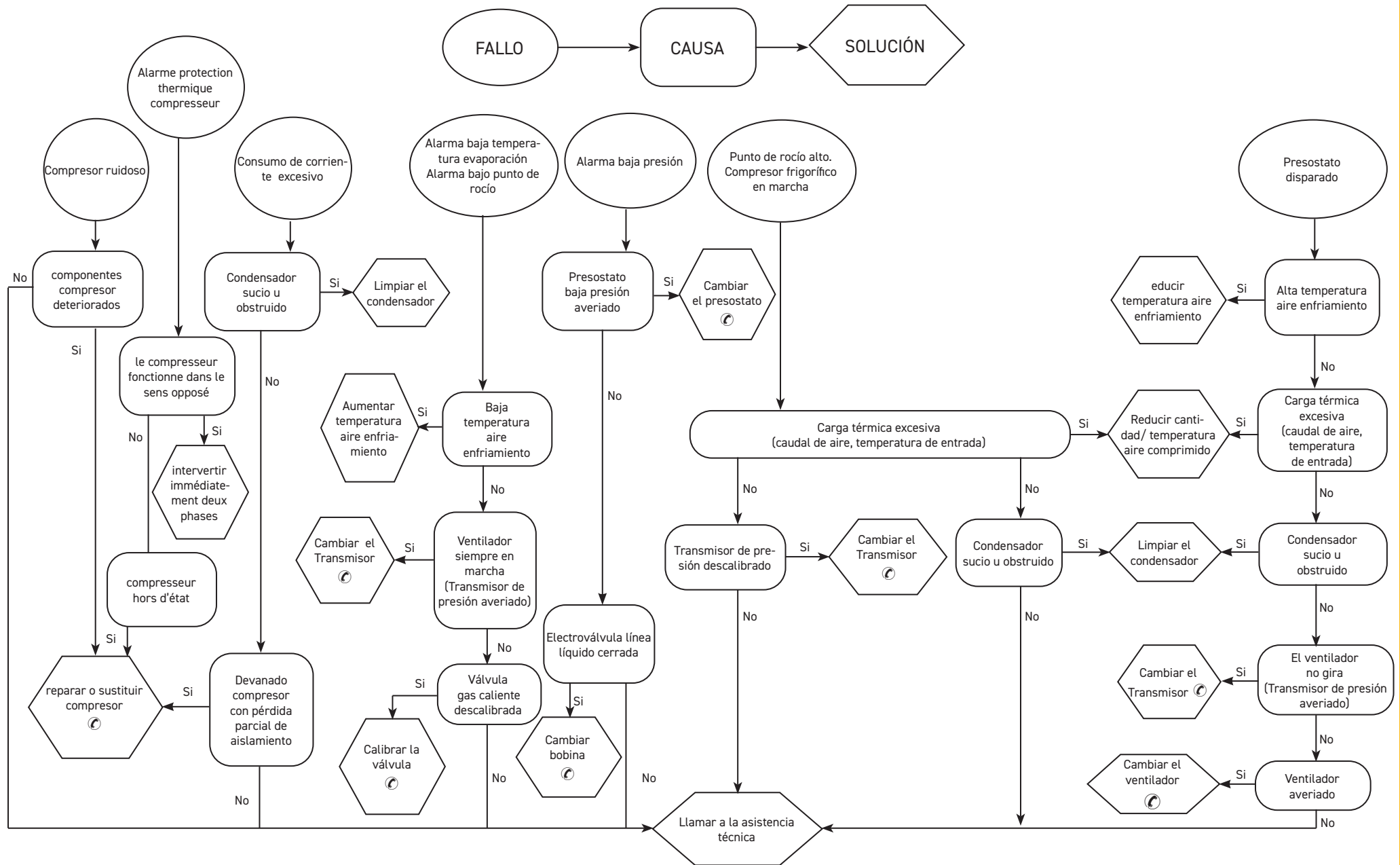

Sommaire

1 Sécurité	2		
1.1 Importance de la notice.....	2		
1.2 Signaux d'avertissement.....	2		
1.3 Consignes de sécurités.....	2		
1.4 Risques résiduels.....	2		
2 Introduction	3		
2.1 Transport.....	3		
2.2 Manutention.....	3		
2.3 Inspection ou visite.....	3		
2.4 Stockage.....	3		
3 Installation	3		
3.1 Procédure.....	3		
3.2 Espace de travail.....	3		
3.3 Version condenseur.....	3		
3.4 Recommandations.....	3		
3.5 Raccordement électrique.....	3		
3.6 Raccordement purgeur des condensats.....	4		
4 Mise en service	4		
4.1 Contrôles préliminaires.....	4		
4.2 Démarrage.....	4		
4.3 Fonctionnement.....	4		
4.4 Arrêt.....	4		
5 Commande (325-500)	5		
5.1 Panneau de commande.....	5		
5.2 Symbole.....	5		
5.3 Réglages des paramètres.....	5		
5.4 Configuration purgeur des condensats.....	6		
5.5 Visualisation des capteurs de température.....	6		
5.6 Modbus ON/OFF.....	7		
5.7 ON/OFF remoto.....	7		
5.8 CYCLING fonction.....	8		
5.9 Gestion des alarmes.....	8		
5.10 Historique des alarmes.....	9		
5.11 Setting clock/date.....	9		
5.12 Software version.....	10		
5.13 Default parameter.....	10		
6 Commande tactile (700-1000)	10		
6.1 Panneau de commande tactile.....	10		
6.2 Menu Information.....	11		
6.2.1 Setting parameter date/time.....	11		
6.2.2 Menu Réglages des paramètres.....	12		
6.2.3 Menu Capteurs.....	16		
6.2.4 Menu Entrée numérique.....	16		
6.2.5 Menu Sortie numérique.....	17		
6.2.6 Menu Numéro de série.....	17		
6.3 Menu Rapide.....	18		
7 Entretien	18		
7.1 Recommandations générales.....	18		
		7.2 Réfrigérant.....	18
		7.3 Programme d'entretien préventif.....	19
		7.4 Mise au rebut.....	19
		8 Dépannage	20
		9 Appendice	

1 Sécurité

1.1 Importance de la notice

- La notice doit être conservée pendant toute la durée de vie de la machine.
- Lire la notice avant toute opération ou intervention.
- La notice est sujette à modifications : pour une information actualisée, consulter la version à bord de la machine.

1.2 Signaux d'avertissement



Instructions pour éviter de faire courir des risques aux personnes



Instructions à suivre pour éviter de faire subir des dégâts à l'appareil.



La présence d'un professionnel qualifié et agréé est exigée



Sont présents des symboles dont la signification est donnée au paragraphe 9.1

1.3 Consignes de sécurités

Chaque unité est munie d'un sectionneur électrique pour permettre toute intervention en conditions de sécurité. Toujours actionner ce dispositif pour éliminer les risques pendant les opérations d'entretien.

La notice s'adresse à l'utilisateur final uniquement pour les opérations pouvant être effectuées panneaux fermés ; par contre, les opérations qui nécessitent l'ouverture avec des outils doivent être confiées à un professionnel expert et qualifié.

Ne pas dépasser les limites définies par le projet, qui sont indiquées sur la plaque des caractéristiques.

Il incombe à l'utilisateur d'éviter des charges différentes de la pression statique interne. En cas de risque d'activité sismique, l'unité doit être convenablement protégée.

Les dispositifs de sécurité sur le circuit d'air sont à la charge de l'utilisateur.

Le dimensionnement des dispositifs de sécurité du circuit de l'air comprimé doit être réalisé en tenant compte des caractéristiques techniques de l'installation et de la réglementation locale en vigueur.

N'utiliser l'unité que pour un usage professionnel et pour la destination prévue par le constructeur. Il incombe à l'utilisateur d'analyser tous les aspects de l'application pour laquelle l'unité est installée, de suivre toutes les consignes industrielles de sécurité applicables et toutes les prescriptions

inhérentes au produit contenues dans le manuel d'utilisation et dans tout autre documentation réalisée et fournie avec l'unité.

La modification ou l'adaptation ou le remplacement d'un composant quelconque par une personne non autorisée et/ou l'usage impropre de l'unité dégagent le constructeur de toute responsabilité et comportent l'annulation de la garantie.

Le constructeur ne saurait être tenu pour responsable pour tous les dommages matériels aux choses ou à l'unité et pour tous les dommages physiques aux personnes dérivant d'une négligence des opérateurs, du non-respect de toutes les instructions de la présente notice, de l'inapplication des normes en vigueur concernant la sécurité de l'installation.

La responsabilité du constructeur est dérogée pour tous les dommages ou dégâts éventuels pouvant résulter de manipulations malveillantes et/ou de modifications de l'emballage.

L'utilisateur doit s'assurer que les conditions fournies pour la sélection de l'unité ou de ses composants et/ou options sont parfaitement conformes pour une utilisation correcte de cette même unité ou de ses composants.

ATTENTION: Le fabricant se réserve le droit de modifier sans aucun préavis les informations contenues dans ce manuel. Afin de disposer d'informations complètes et actualisées, il est recommandé à l'utilisateur de consulter le fabricant.

1.4 Risques résiduels

L'installation, la mise en marche, l'arrêt et l'entretien de la machine doivent être effectués conformément aux dispositions prévues par la documentation technique du produit et, quoiqu'il en soit, de manière à ne créer aucune situation de risque.

Les risques n'ayant pu être éliminés en phase de conception sont indiqués dans le tableau suivant.

partie concernée	risque résiduel	modalité	précautions
batterie d'échange thermique	petites coupures	contact	éviter tout contact, porter des gants de protection
grille ventilateur et ventilateur	lésions	introduction d'objets pointus à travers la grille lors du fonctionnement du ventilateur	n'introduire aucune sorte d'objets dans la grille des ventilateurs et ne poser aucun objet sur les grilles
partie interne de l'unité : compresseur et tuyau de refoulement	brûlures	contact	éviter tout contact, porter des gants de protection
partie interne de l'unité : parties métalliques et câbles électriques	intoxications, brûlures graves	incendie dû à un court-circuit ou une surchauffe de la ligne d'alimentation en amont du tableau électrique de l'unité	section des câbles et système de protection de la ligne d'alimentation électrique conformes aux normes en vigueur
partie externe de l'unité : zone environnante de l'unité	intoxications, brûlures graves	incendie dû à un court-circuit ou une surchauffe de la ligne d'alimentation en amont du tableau électrique de l'unité	section des câbles et système de protection de la ligne d'alimentation électrique conformes aux normes en vigueur

2 Introduction

Ce manuel fait référence aux sècheurs frigorifiques conçus pour éliminer la vapeur d'eau de l'air comprimé.

2.1 Transport

L'unité emballée doit rester :

- en position verticale ;
- à l'abri des intempéries ;
- à l'abri des chocs.

2.2 Manutention

Utiliser un chariot élévateur d'une capacité suffisante à soulever le poids de la machine. Éviter tous chocs pendant la manutention.

2.3 Inspection ou visite

- En usine, toutes les unités sont assemblées, câblées, chargées avec du réfrigérant et de l'huile et testées dans les conditions de travail normales ;
- après réception de la machine, l'examiner soigneusement pour vérifier son état : recourir contre le transporteur pour les dommages éventuellement survenus au cours du transport ;
- débaler l'unité le plus près possible de son lieu d'implantation.

2.4 Stockage

En cas d'empilage de plusieurs unités, suivre les instructions inscrites sur l'emballage. Conserver l'unité dans son emballage en un lieu propre et à l'abri de l'humidité et des intempéries.

3 Installation

☞ Installez à l'intérieur dans un endroit propre et sec qui est protégé des éléments, de la lumière directe du soleil et / ou d'autres conditions difficiles.

⚠ Le produit installé doit être convenablement protégé contre les risques d'incendie (réf. EN378-3).

3.1 Procédure

☞ Respecter les indications des paragraphes 9.2 et 9.3.

Tous les sècheurs doivent être équipés d'une préfiltration adéquate située à immédiate proximité de l'entrée du sécheur. Le revendeur se dégage de toute responsabilité en cas de dommage direct ou indirect causé par l'absence de ce préfiltre.

☞ L'élément préfiltrant (filtration des particules de 3 microns minimum) doit être remplacé une fois par an ou plus, selon les recommandations du fabricant.

☞ Connecter correctement le sécheur aux prises d'entrée et de sortie de l'air comprimé.

3.2 Espace de travail

☞ Prévoir un espace de dégagement de 1.5 m autour de l'unité.

Laisser 2 m d'espace au-dessus du sécheur pour les modèles à évacuation verticale de l'air de refroidissement.

dissement.

3.3 Version condenseur

Version à air (Ac)

Ne pas créer des situations de recyclage de l'air de refroidissement.

Ne pas obstruer les grilles de ventilation.

Version à eau (Wc)

Si la fourniture ne le prévoit pas, monter une crépine sur l'entrée de l'eau de condensation.

☞  Caractéristiques de l'eau de condensation en entrée :

Température	≥50°F (10°C)	CL ⁻	<50 ppm
ΔT IN/OUT	5-15°C	CaCO ₃	70-150 ppm
Max % glycole	50	O ₂	<0.1 ppm
Pression	43.5-145 PSig (3-10 barg)	Fe	<0.2 ppm
PH	7.5-9	NO ₃	<2 ppm
Conductivité électrique	10-500 μS/cm	HCO ₃ ⁻	70-300 ppm
Indice de saturation de Langelier	0-1	H ₂ S	<0.05 ppm
SO ₄ ²⁻	<50 ppm	CO ₂	<5 ppm
NH ₃	<1 ppm	Al	<0.2 ppm

Pour des eaux de refroidissement spéciales (déionisée, déminéralisée, distillée) les matériaux standard prévus pour le condenseur pourraient ne pas être appropriés. Dans ce cas, veuillez contacter le constructeur.

3.4 Recommandations

Pour ne pas endommager les composants internes du sécheur et du compresseur d'air, éviter des installations où l'air des zones environnantes contient des contaminants : attention donc au soufre, à l'ammoniac, au chlore et aux installations en milieu marin.

Pour les versions avec ventilateurs axiaux, il est déconseillé de canaliser l'air épuisé.

3.5 Raccordement électrique

Utiliser un câble homologué aux sens des normes françaises en matière d'électricité et de la réglementation locale (pour la section minimale du câble, voir paragraphe 9.3).

Installer l'interrupteur magnéto-thermique différentiel en amont de l'installation (RCCB - IDn = 0.3A) avec une distance d'ouverture des contacts 3 mm (voir réglementation locale en vigueur en la matière et s'y conformer).

Le courant nominal «In» de ce disjoncteur magnéto-thermique doit être égal à FLA et la courbe de déclenchement de type D.

Sélectionnez l'alimentation et insérez un pont comme indiqué ci-dessous

S7-S6 pour 400/3/50

S8-S6 pour 460/3/60

À l'intérieur du panneau électrique, il y a une étiquette d'instructions.

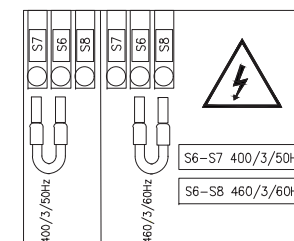

3.6 Raccordement purgeur des condensats

☞ Réaliser le raccordement au système de décharge en évitant le raccordement en circuit fermé en commun avec les autres circuits de décharge pressurisés. Contrôler que les systèmes de décharge évacuent régulièrement les condensats. Évacuer tous les condensats conformément à la législation antipollution en vigueur.

4 Mise en service

4.1 Contrôles préliminaires

Avant la mise en service du dessiccateur, vérifier que :

- l'installation a été réalisée conformément aux instructions fournies à la Section 3 ;
- la soupape d'admission d'air est ouverte et aucun écoulement d'air n'est présent dans le dessiccateur ;
- l'alimentation fournie est correcte ;
- en version Wc, ouvrir le circuit d'eau de refroidissement quelques minutes avant de démarrer le dessiccateur..

4.2 Démarrage

1. Mettre sous tension en tournant l'interrupteur général "  " sur « I ON » :
(pour le modèle 0325-0500) il y a une étiquette sous le contrôle pour informer que :

☞ **THE CRANKCASE HEATER MUST BE SWITCHED ON 12 HOURS BEFORE STARTING THE DRYER.**
(pour le modèle 0700-1000) apparaissent sur l'écran:

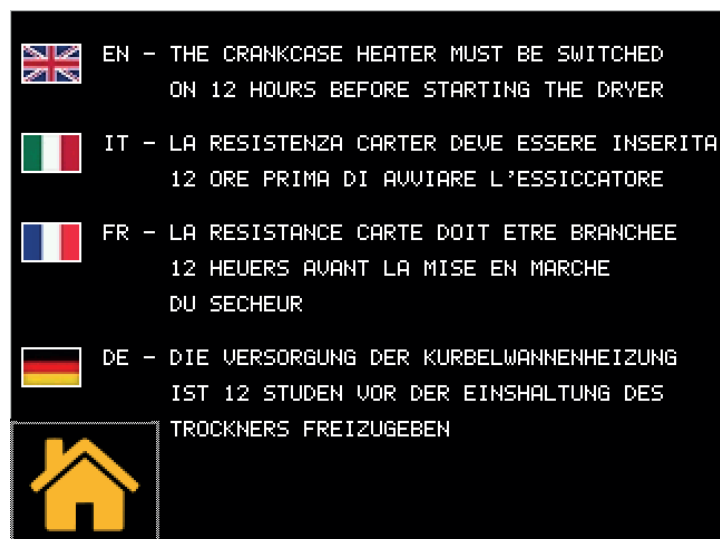

Appuyer  pour revenir le panneau de commande

2. Appuyer sur  pour démarrer (modèles 325-500).

Appuyer sur  pour démarrer (modèles 700-1000).

3. Démarrer le dessiccateur avant le compresseur d'air.

☞ Ventilateurs (version Ac) : s'ils sont raccordés dans l'ordre de phases incorrect, ils tourneront dans la direction opposée, avec le risque qu'ils subissent des dégâts (dans ce cas, l'air sort de l'armoire du dessiccateur par les grilles du condenseur plutôt que par les grilles des ventilateurs - pour le débit d'air correct, voir le par 9.8) ; inverser immédiatement deux phases.

4. Attendre 5 minutes, puis ouvrir lentement la soupape d'admission d'air.
5. Ouvrir lentement la soupape d'échappement d'air : le dessiccateur fonctionne maintenant en mode séchage.



Moniteur des phases

Si une alarme s'affiche pendant le démarrage du dessiccateur, l'utilisateur doit vérifier le câblage des bornes d'entrée du sectionneur du dessiccateur.

4.3 Fonctionnement

- Laisser le dessiccateur en marche tout le temps que le compresseur d'air fonctionne.
- Le dessiccateur travaillant en automatique, les réglages de champ ne sont pas nécessaires.
- En cas de débits d'air excessifs imprévus, les by-passer pour éviter toute surcharge du dessiccateur.
- Éviter les variations de température d'entrée.

4.4 Arrêt





1. Arrêter le dessiccateur 2 minutes après l'arrêt du compresseur d'air, ou en tout cas lorsque le débit d'air est interrompu.
2. Vérifier que l'air comprimé ne pénètre pas dans le dessiccateur quand le dessiccateur est débranché ou si une alarme s'est déclenchée.
3. Appuyer sur  pour arrêter le dessiccateur (modèles 325-500).
Appuyer sur  pour arrêter le dessiccateur (modèles 700-1000).
4. Tourner l'interrupteur général "  " sur « 0 OFF » pour mettre hors tension.

☞ En version Wc, fermer le circuit d'eau avec le dessiccateur arrêté.









5 Commande (325-500)

5.1 Panneau de commande



-  Bouton flèche vers le haut : appuyer pour augmenter la valeur d'un paramètre sélectionné.
PRESSÉ PENDANT 3s POUR DÉMARRER LA PURGEUR DE L'EAU DE CONDENSATION MANUELLE
-  Bouton flèche vers le bas : appuyer pour diminuer la valeur d'un paramètre éditable sélectionné.
-  Bouton ESC : pour quitter sans enregistrer ; revient au niveau précédent.
ENFONCÉ PENDANT 5 S. RÉINITIALISATION DE L'ALARME.
-  Bouton SET : pour quitter et enregistrer / confirmer la valeur ; passer au niveau suivant ; ouvrir le menu Réglage.
ENFONCÉ PENDANT 5 S. DÉMARRAGE DU DESSICCATEUR.
-  : appuyer dessus en même temps pour accéder aux paramètres du programme.









5.2 Symbole

Symbole	Symbol status	Function	Symbole	Symbol status	Function
	Allumé	Compresseur en marche		Allumé	Dessiccateur ON Compresseur OFF
	Éteint	Compresseur arrêté		Allumé	Maintenance
	Allumé	Dessiccateur en marche		Allumé	Maintenance
	Clignotant	Dessiccateur arrêté		°C °F	Allumé
	Allumé	Alarme présente	Bar PSI	Allumé	Pression
	Clignotant	Avertissement présent			Grade
	Éteint	Aucune alarme présente			
	Allumé	Purgeur de l'eau de condensation en marche		Pression	
	Éteint	Purgeur de l'eau de condensation arrêté			

5.3 Réglages des paramètres

Unité de mesure de la température

Réglage de l'unité de mesure de la température.

1. Appuyer simultanément sur  et  pour ouvrir le menu général "PAr".
2. Appuyer sur  pour ouvrir le menu "CF9".
3. Appuyer sur  pour ouvrir.
4. Utiliser les flèches  ou  pour trouver le menu "R1".
5. Appuyer sur  pour choisir : ON = Fahrenheit (PSI) / OFF = Celsius(bar).
6. Appuyer sur  pour confirmer.
7. Appuyer sur  pour quitter.

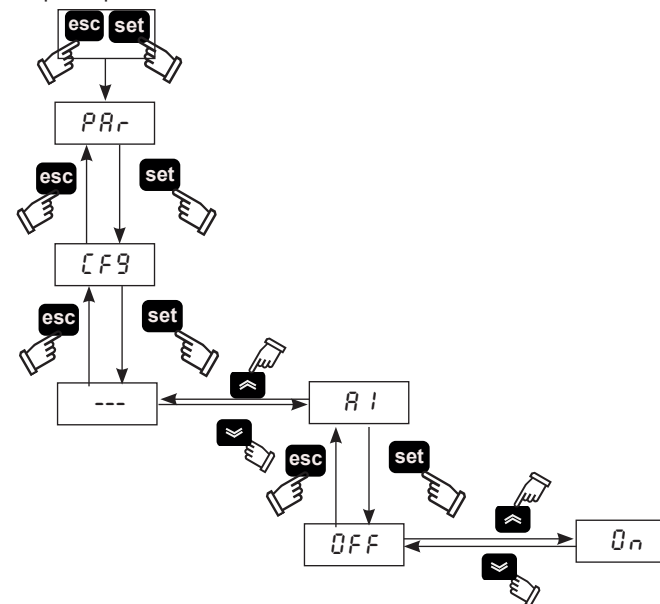

5.4 Configuration purgeur des condensats

Trois modes de fonctionnement sont disponibles :

- CAPACITIF = Purge automatique à l'aide d'un capteur capacitif ;
- TEMPORISÉ = durées de purge programmables ;
- CONTINU (externe) = en présence d'un purgeur externe.

1. Appuyer simultanément sur **set** et **esc** pour ouvrir le menu général "PAr".
2. Appuyer sur **set** pour ouvrir.
3. Utiliser les flèches **⏪** ou **⏩** pour trouver le menu "Cd".
4. Appuyer sur **set** pour ouvrir.
5. Utiliser les flèches **⏪** ou **⏩** pour trouver le paramètre "d3".
6. Appuyer sur **set** pour choisir le type de purgeur :
0 = externe ;
1 = temporisé ;
2 = capacitif
7. Appuyer sur **set** pendant cinq secondes pour sélectionner le purgeur.

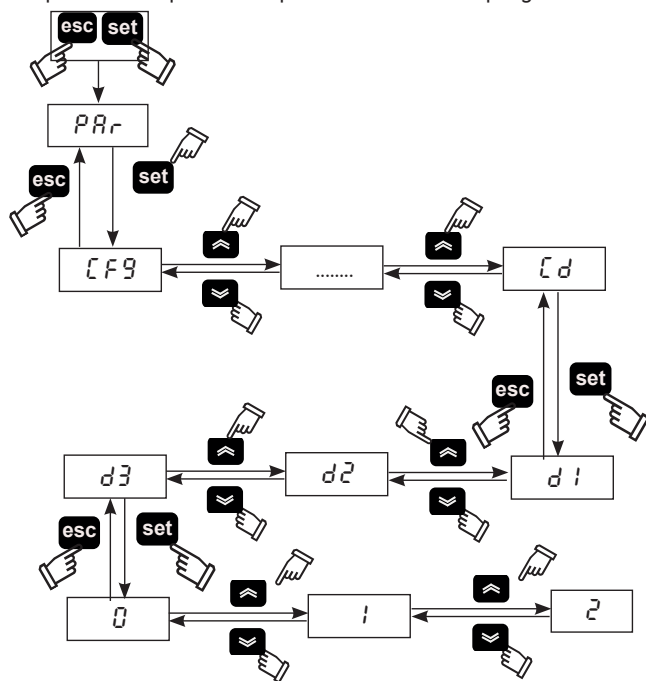

Pour l'option purgeur temporisé (1), il est possible de régler la durée ON/OFF du purgeur. Dans le menu "Cd"

1. Utiliser les flèches **⏪** ou **⏩** pour trouver le paramètre "d1" afin de choisir la durée d'ouver-

ture.

2. Appuyer sur **set** pour confirmer.
3. Utiliser les flèches **⏪** ou **⏩** pour trouver le paramètre "d2" afin de choisir la durée d'ouverture.
4. Appuyer sur **set** pour confirmer.
5. Appuyer sur **esc** pour quitter.

5.5 Visualisation des capteurs de température

La température du point de rosée s'affiche par défaut.

Pour afficher d'autres températures, procéder de la manière suivante :

Utiliser les flèches **⏪** ou **⏩** pour choisir le capteur..

- b0 = capteur de température du point de rosée ;
- b2 = capteur de température d'évaporation ;
- b5 = capteur de température du compresseur d'aspiration ;
- b8 = capteur de température de condensation ;
- P1 = capteur de haute pression ;

Dès que le choix est effectué, attendre quelques secondes pour voir la valeur relevée.

6. Appuyer sur **esc** pour quitter.

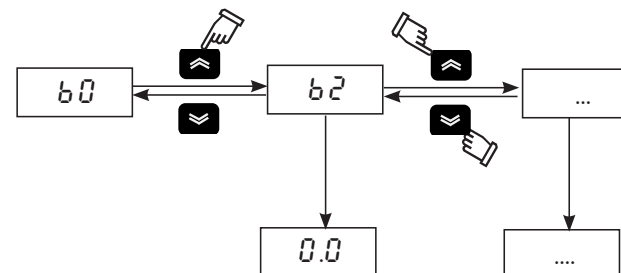

Si vous éteignez le dessiccateur avec **set**, lorsque vous allumez le capteur que vous avez choisi, la valeur reste mémorisée.

Si vous éteignez le dessiccateur avec l'INTERRUPTEUR PRINCIPAL "⏻", lorsque vous allumez, vous revenez à la lecture du capteur B0.

5.6 Modbus ON/OFF

1. Appuyer simultanément sur **set** et **esc** pour ouvrir le menu général "PAr".
2. Appuyer sur **set** pour ouvrir le menu "CF9".
3. Utiliser les flèches **⏴** ou **⏵** pour trouver le paramètre "A5", "CF30", "CF31", "CF32".
4. Appuyer sur **set** pour ouvrir.

PARAMÈTRE	CODE	TYPE	DEFAULT
Activation distante on/off Modbus	A5	D	OFF
Adresse de l'unité	CF30	D	1
Baud rate	CF31	D	5
Parity	CF32	D	1

Activation Modbus

Active la fonction modbus.

Baud rate

1	2400	3	9600	5	38400	7	115200
2	4800	4	19200	6	57600		

Parity : 1 = EVEN; 2 = NONE; 3 = ODD

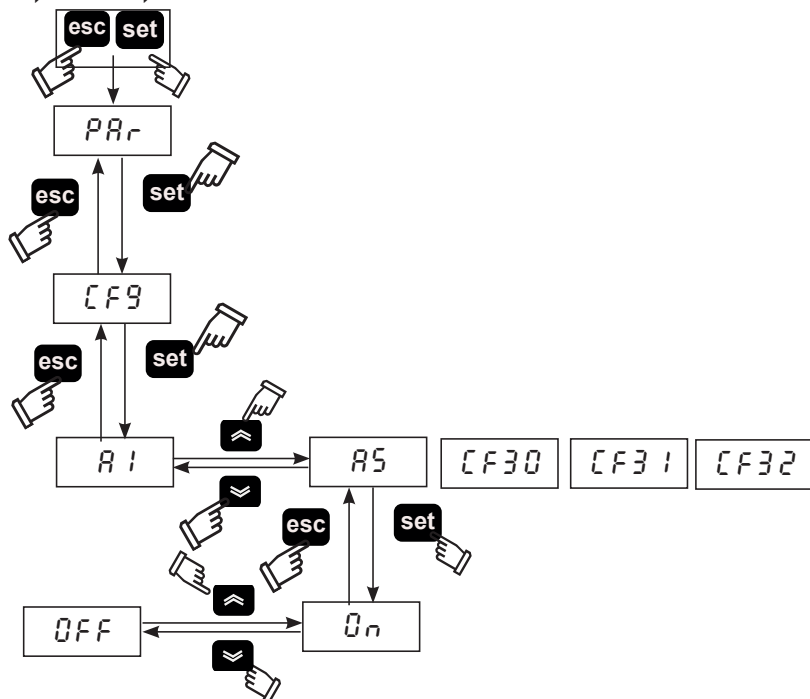

Adresse de l'unité

Donnez une adresse à votre unité

5.7 ON/OFF remoto

1. Appuyer simultanément sur **set** et **esc** pour ouvrir le menu général "PAr".
2. Appuyer sur **set** pour ouvrir le menu "CF9".
3. Utiliser les flèches **⏴** ou **⏵** pour trouver le paramètre "A7".
4. Appuyer sur **set** pour ouvrir.
5. Utiliser les flèches **⏴** ou **⏵** pour choisir:
ON : remote ON;
OFF: remote OFF.
6. Appuyer sur **set** pour confirmer.
7. Appuyer sur **esc** pour quitter.

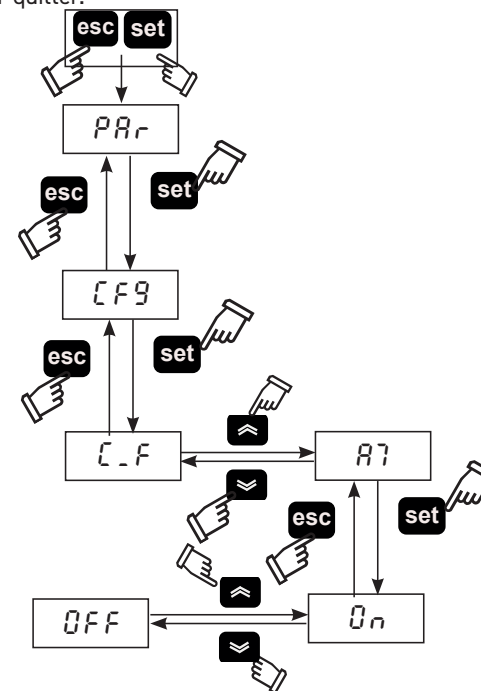

☞ Pour gérer le mode REMOTE OFF, retirer le pont entre les bornes : 87 -GND et brancher l'interrupteur marche/arrêt à distance (à prévoir par le client).

5.8 CYCLING function

1. Appuyer simultanément sur **set** et **esc** pour ouvrir le menu général "PAr".
2. Appuyer sur **set** pour ouvrir le menu.
3. Utiliser les flèches **⏴** ou **⏵** pour trouver le paramètre "C4C".
4. Appuyer sur **set** pour ouvrir.
5. Utiliser les flèches **⏴** ou **⏵** pour trouver le paramètre "C7".
6. Appuyer sur **set** pour choisir:
ON : continuous;
OFF: cycling.
7. Appuyer sur **set** pour confirmer.
8. Appuyer sur **esc** pour quitter.

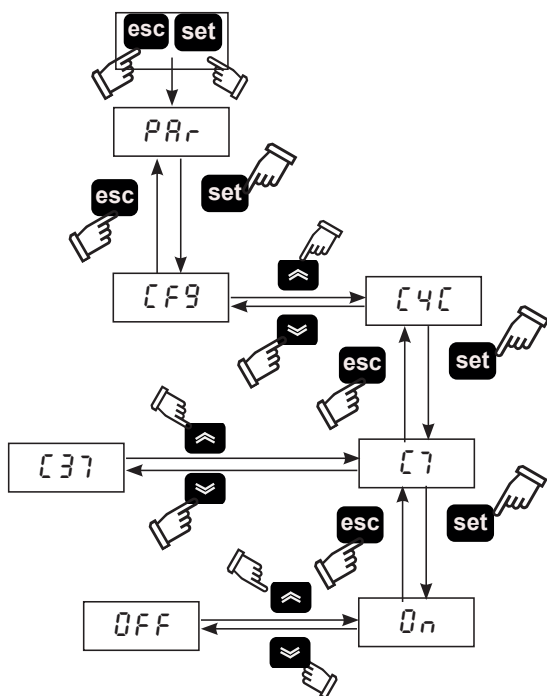

"C37" afficher le % d'économie d'énergie.

5.9 Gestion des alarmes

1. Appuyer simultanément sur **set** et **esc** pour ouvrir le menu général "PAr".
2. Appuyer sur **set** pour ouvrir le menu "CF9".
3. Utiliser les flèches **⏴** ou **⏵** pour trouver le paramètre "CFJ1".

PARAMÈTRE	CODE	TYPE	DEFAULT
Gestion des alarmes	CFJ1	D	OFF

OFF = alarme; On = Avertissement /alarme

En cas d'alarme/avertissement, procéder de la manière suivante :

1. Appuyer sur **set** pour ouvrir le menu des paramètres directs.
2. Utiliser les flèches **⏴** ou **⏵** pour trouver le paramètre "AL".
3. Appuyer sur **set** pour voir le code d'alarme:

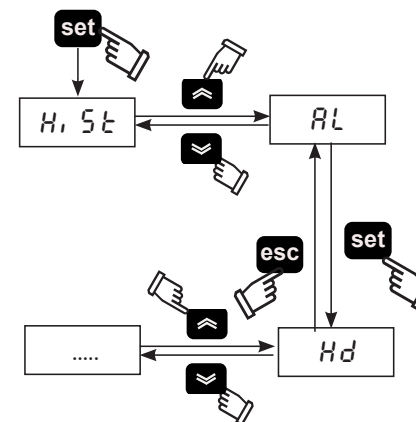

Liste des alarmes				Liste des Avertissement			
H.C.	Cod.	Description	Reset	H.C.	Cod.	Description	Reset
10	LD	Point de rosée bas	M	1/2	FB0/2	Avertissement capteur B0/B2	A
11	LT	Température d'évaporation basse	M	3/5	FB5/8	Avertissement capteur B5/B8	A
13	HT2	Température de reflux élevée	M	7	FP1	Avertissement capteur PI	A
18	HP	Haute pression	M	24	DRE	Avertissement purgeur de l'eau de condensation	A
19	LP	Basse pression	M	9	HD	Avertissement point de rosée élevé	A
21	PI	Protection thermique du compresseur	M	12	HT1	Température de reflux élevée	A
22	PH	Inversion des phases	M	14	HB5	Température élevée à l'aspiration du compresseur	A
				20	HP1	Haute pression	A
				25	SR	Entretien	A

(H.C=History code)

5.10 Historique des alarmes

En cas d'alarme/avertissement, pour voir les alarmes actuelles et précédentes, procéder de la manière suivante :

1. Appuyer sur **set** pour ouvrir le menu "H, S t".
2. Appuyer sur **set** pour ouvrir le paramètres :

Menu	Code	Description
HiSt	HiSP	Position de l'alarme
	HiSC	Code d'alarme
	HiSd	Date de l'alarme (si l'option Horloge est présente)
	HiSt	Heure de l'alarme (si l'option Horloge est présente)
	HiS1/2.	valeur du capteur

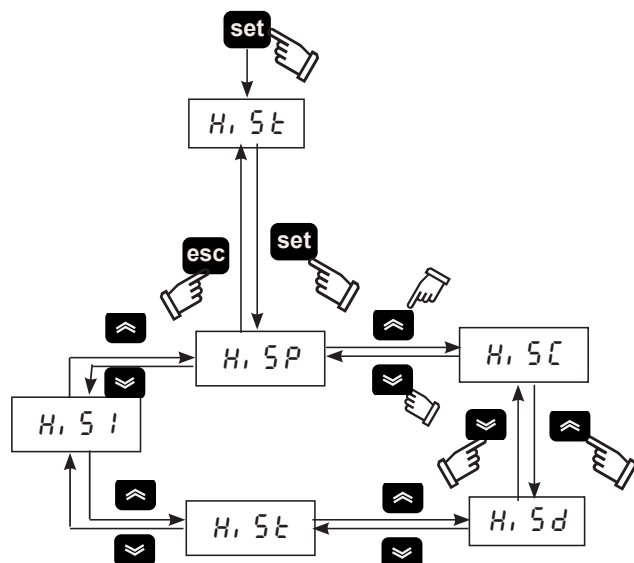

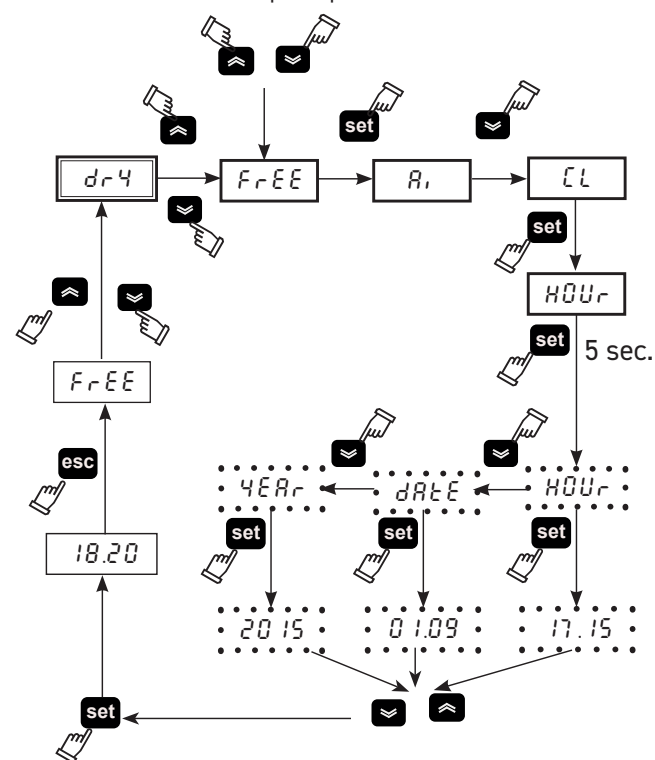

5.11 Setting clock/date

1. Appuyer simultanément "⏮" "⏭", pour ouvrir le menu "FrEE".
2. Appuyer sur **set** pour ouvrir menu "A, ".
3. Appuyer sur ⏭ pour ouvrir menu "CL".
4. Appuyer sur "set" pour accéder et afficher le paramètre "HOUr".
5. Appuyer sur "set" jusqu'à ce que le paramètre "HOUr" clignote.
6. Sélectionner le paramètre qui clignote "HOUr" / "dAtE" / "4EAR" à l'aide "⏮" et appuyer sur "set" pour ouvrir le menu.
7. Modifier la valeur qui clignote à l'aide "⏮" et "⏭" (haut et bas), puis appuyer sur "set" pour confirmer.
8. Press "esc" pour revenir au menu "FrEE".
9. Appuyer simultanément "⏮" "⏭" pour quitter.





⚠ La mémoire de l'« horloge/date » dure trois jours au maximum. Si le contrôleur reste sans alimentation pendant plus de trois jours, l'heure/le mois/l'année paramétrés seront donc perdus. Régler l'horloge lors de la mise en marche de la machine et chaque fois que cela est nécessaire.

5.12 Software version

1. Appuyer simultanément sur **set** et **esc** pour ouvrir le menu général "PR".
2. Appuyer sur **set** pour ouvrir le menu "CF".
3. Utiliser les flèches  ou  pour trouver le paramètre "UE".
4. Appuyer sur **set** pour voir la version du logiciel.









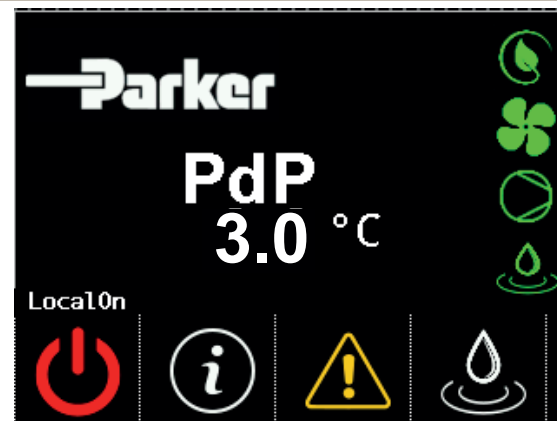



5.13 Default parameter

1. Appuyer simultanément sur **set** et **esc** pour ouvrir le menu général "PR".
2. Appuyer sur **set** pour ouvrir le menu "CF".
3. Utiliser les flèches  ou  pour trouver le paramètre "DEF".
4. Appuyer sur **set** pour ouvrir.
5. Passez de OFF à ON et appuyez sur **set** pour définir la valeur par défaut.

6 Commande tactile (700-1000)

6.1 Panneau de commande tactile





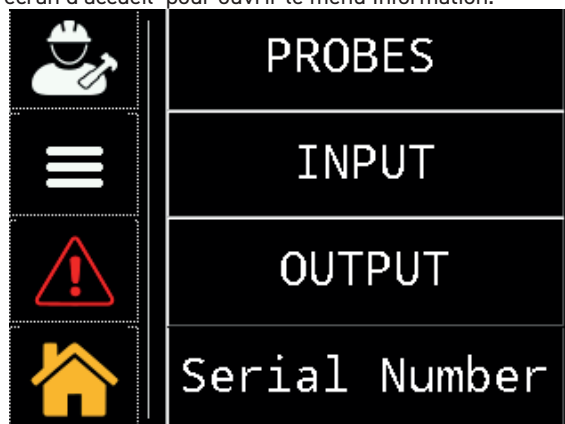

Symbole	État du symbole	Function	Symbole	État du symbole	Function
	Vert	Dessiccateur en marche		Present	S'allume avec le dessiccateur en marche, compresseur arrêté et sans alarme (cycle)
	Rouge	Dessiccateur arrêté			
	-	Appuyer pour ouvrir le menu Information		Present	S'allume avec le ventilateur en marche
	Rouge	Dessiccateur en marche		Present	S'allume avec le compresseur en marche
	Jaune	Dessiccateur arrêté			
	Absent	Alarme présente			
	-	Appuyer pour activer manuellement le purgeur		Present	S'allume avec le purgeur en marche
	-	Date/Temps		-	Continu Cycle
	-	Température de point de rosée		Remote Local	Remote = remote ON Local = remote OFF

6.2 Menu Information

Appuyer sur  sur l'écran d'accueil pour ouvrir le menu Information.



Symbole	Function
	Appuyer pour ouvrir les menus Service / Usine : ces menus sont protégés par mot de passe. L'accès est autorisé uniquement au personnel qualifié ou certifié Parker.
	Appuyer pour ouvrir le menu Réglages des paramètres : A6, A8 ; °C ou °F ; local ou à distance ; durées de marche/arrêt du purgeur ; heures de fonctionnement.
	Appuyer pour afficher tous les signaux d'alarme / avertissement disponibles.
	Appuyer pour revenir à Écran principal
PROBES	Appuyer pour afficher les capteurs : B0, B2, B5, B8, P1,
INPUT	Appuyer pour afficher l'entrée numérique.
OUTPUT	Appuyer pour afficher la sortie numérique.
Serial Number	Appuyer pour obtenir des informations sur le dessiccateur : numéro de série, version de logiciel PLC / HMI.

6.2.1 Setting parameter date/time

Appuyer sur  pour ouvrir le menu User/service.

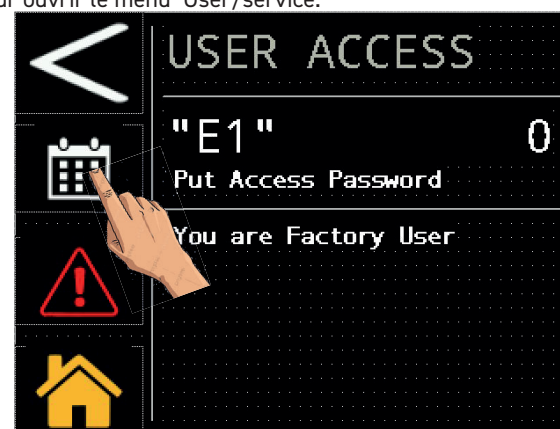



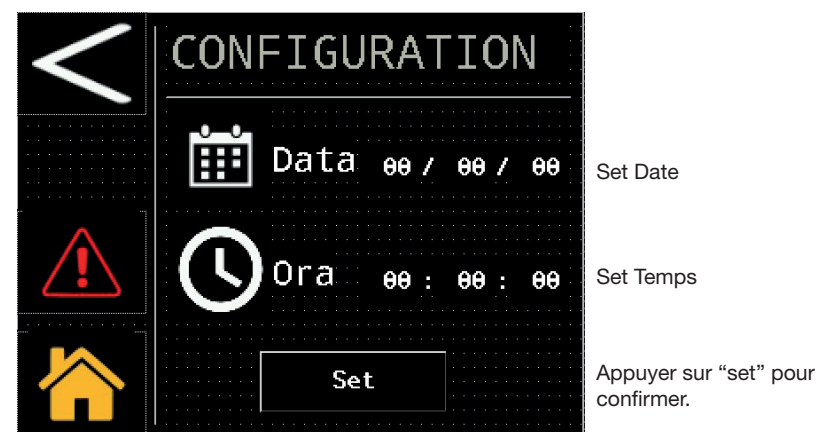



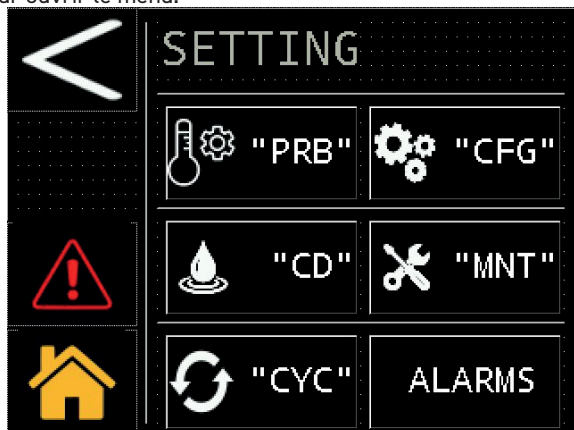

Appuyer sur  pour ouvrir le menu Date/Temps



6.2.2 Menu Réglages des paramètres

Appuyer sur  pour ouvrir le menu.



Symbole	Function
	Appuyer pour revenir en arrière.
	Appuyer pour poursuivre.
	Appuyer pour afficher les seuils de la sortie analogique du point de rosée « A6 / A8 ».
	Appuyer pour configurer : unité de mesure ; démarrage local / à distance et signalisation des alarmes.
	Appuyer pour configurer le purgeur.
	Appuyer pour afficher les heures de fonctionnement et la durée restante avant le prochain entretien prévu.
	Appuyer pour configurer le dessiccateur.
	Appuyer pour réinitialiser l'alarme.

Capteurs

Appuyer sur  "PRB" pour ouvrir.

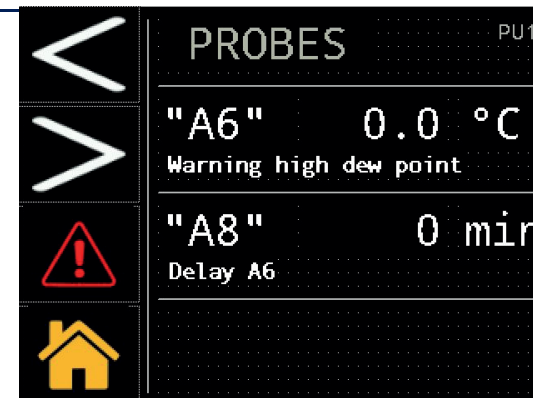

Ces paramètres sont accessibles en mode lecture/écriture, il est possible de modifier : le seuil d'avertissement du point de rosée élevé et le délai. Pour modifier le paramètre, appuyer sur la valeur, comme illustré.



Le clavier servant à saisir la nouvelle valeur souhaitée apparaît.

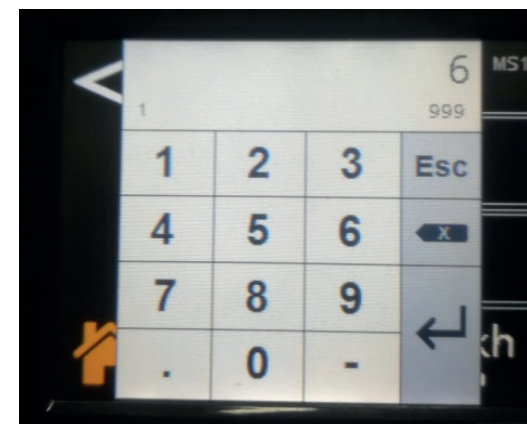

Configuration

Appuyer sur  "CFG" pour ouvrir.

Unité de mesure (°C or °F)

Appuyer sur la case à droite et introduire le drapeau  pour changer et confirmer.

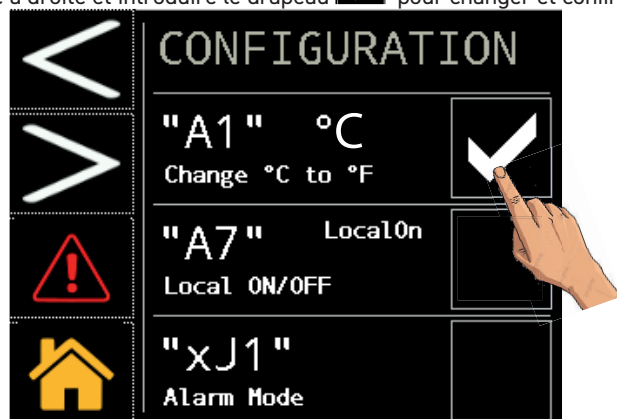

Démarrage local ou à distance

 Pour gérer le mode REMOTE OFF, retirer le pont entre les bornes : 87-92 et brancher l'interrupteur marche/arrêt à distance (à prévoir par le client).

Pour modifier le paramètre ("local ON ou rOFF") Appuyer sur la case à droite et introduire le drapeau

 pour changer et confirmer.

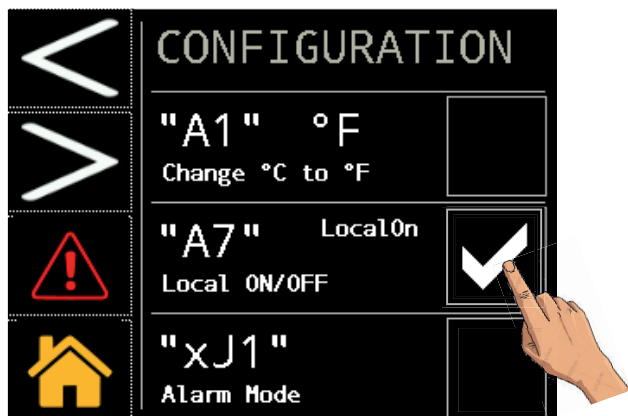

Alarme/avertissement

Appuyer sur la case à droite et introduire le drapeau  pour changer et confirmer.

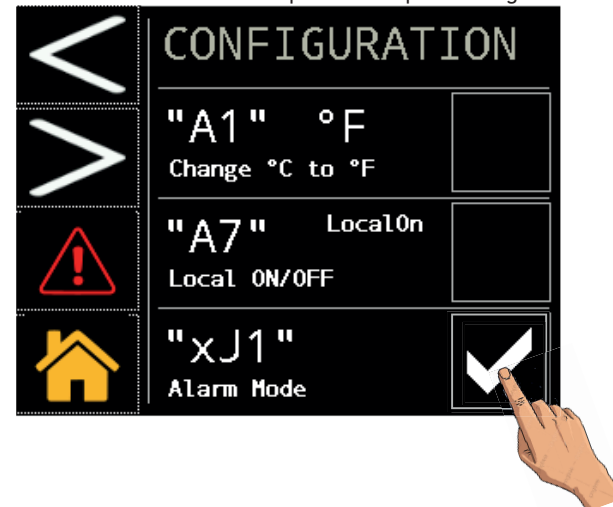

Appuyer sur  pour poursuivre.

Default parameters

Pour rétablir les paramètres par défaut, appuyer comme illustré.

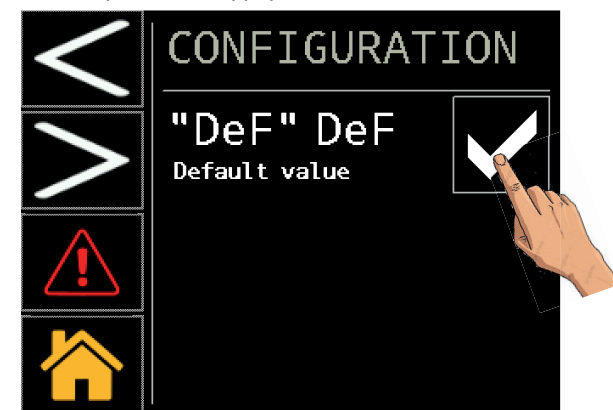

Les paramètres sont réinitialisés automatiquement.

Appuyer sur  pour poursuivre.

Modbus

Choisissez vos options. MODBUS RTU (RS485)

PARAMÈTRE	Cod.	Default
Unit address	CF30	16
Baud rate	CF31	19200
Parity	CF32	2

Parity: 0=NONE; 1=ODD; 2=EVEN;

Baud rate			
0	9600	3	57600
1	19200	4	76800
2	38400	5	115200

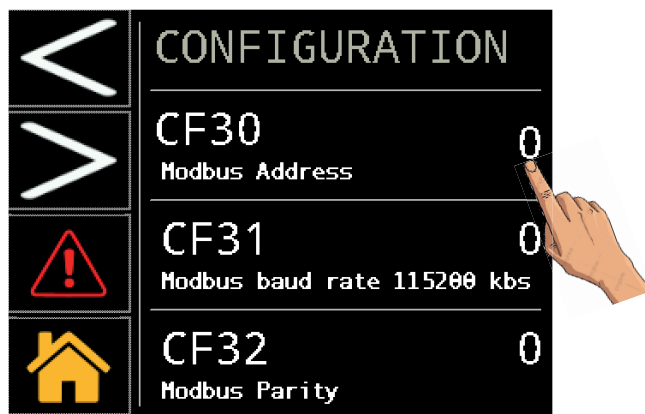

Appuyer sur  pour poursuivre. MODBUS TCP/IP

Choisissez vos options.

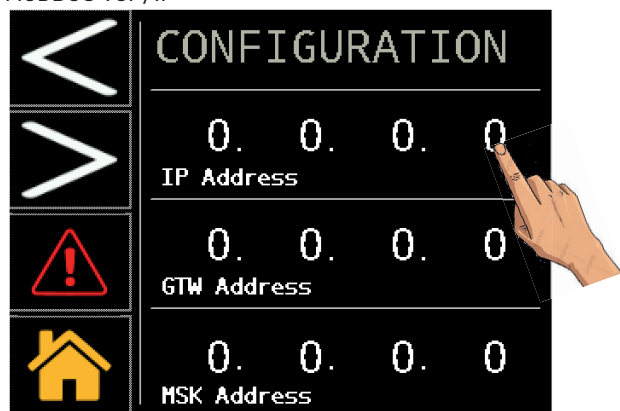

Appuyer sur  pour poursuivre.

Choisissez vos options.

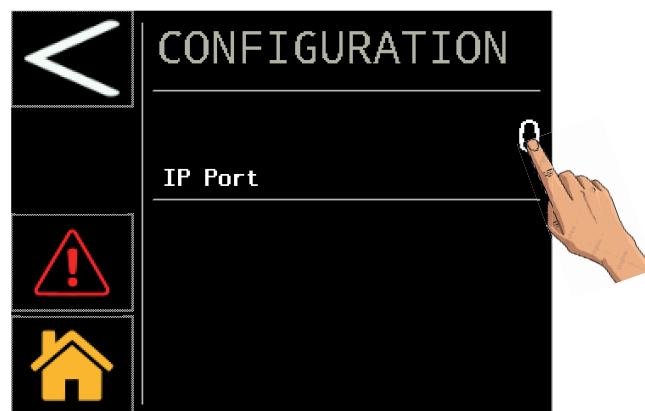

Purgeur

Appuyer sur  pour ouvrir.

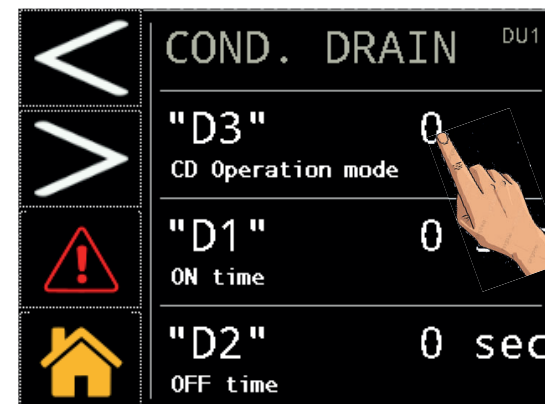

Appuyer comme illustré pour choisir le type du purgeur :

- 0 = externe ;
- 1 = temporisé ;
- 2 = capacitif.

Si le purgeur temporisé (1) est sélectionné, il est également possible de choisir les durées de fermeture et d'ouverture "D1 / D2".

Maintenance

Appuyer sur  pour ouvrir.

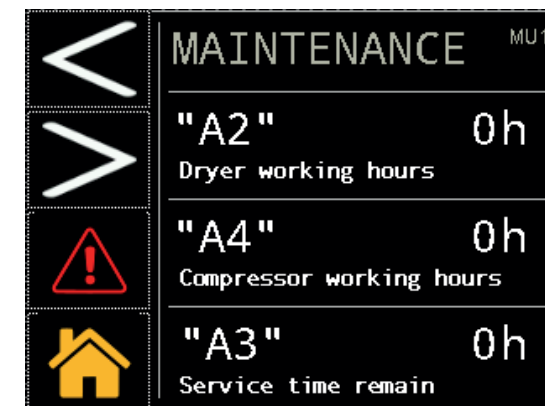



Ces données sont uniquement disponibles en mode lecture.

Operating "cycling"

Appuyer sur  pour ouvrir.

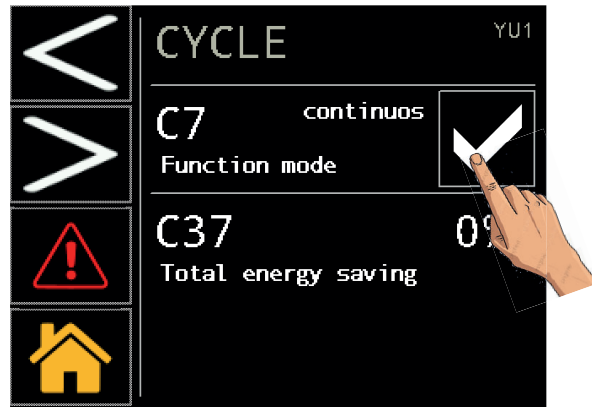
Appuyer comme illustré pour choisir entre mode continu et mode cycle.



Appuyer sur la case à droite et introduire le drapeau  pour changer et confirmer.

Alarm menu

Appuyer sur  pour ouvrir le menu.

Pour afficher les alarmes/avertissements ou procéder à la réinitialisation.



Appuyer sur  pour afficher la page des alarmes.

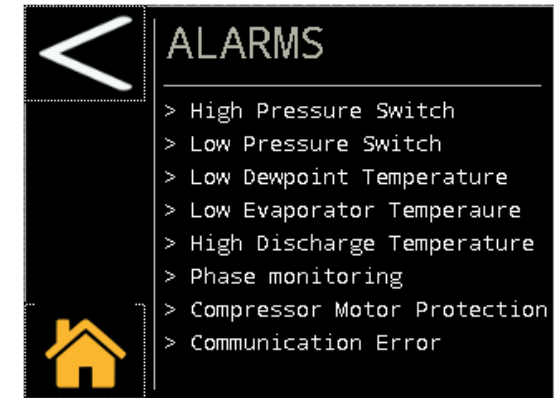

Le message avec la description n'apparaît que si l'alarme est présente.

Appuyer sur  pour afficher la page des avertissements.

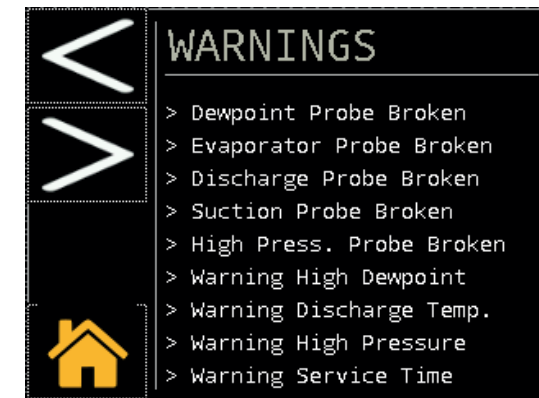

Le message avec la description n'apparaît que si l'avertissement est présent.

Appuyer sur  pour réinitialiser l'alarme. Ne pas oublier que l'alarme ne peut être réinitialisée que si les conditions de fonctionnement nominales ont été rétablies.

6.2.3 Menu Capteurs

Appuyer sur **PROBES** pour ouvrir.

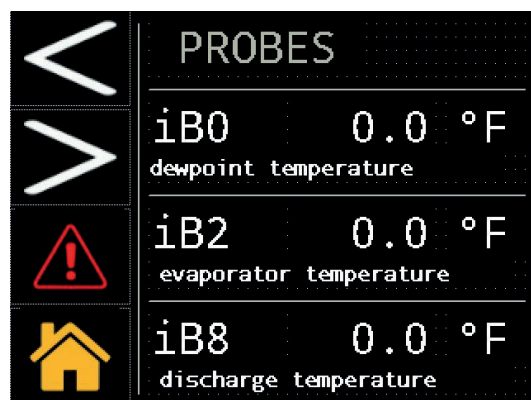

Appuyer sur  pour poursuivre.

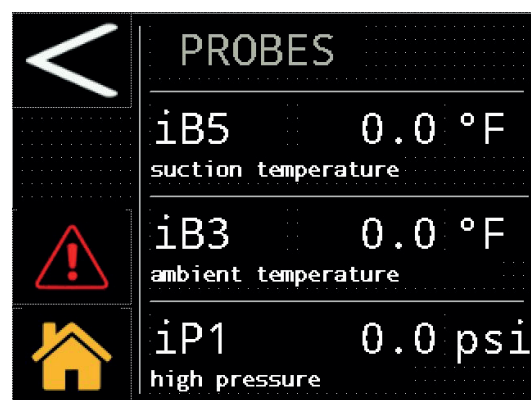

Les valeurs de capteurs s'affichent en temps réel :

- iB0 : Température de point de rosée.
- iB2 : Température d'évaporation.
- iB8 : Température du compresseur de refoulement.
- iB5 : Température du compresseur d'aspiration.
- iB3 : Température ambiante.
- iP1 : Haute pression (condenseur).

6.2.4 Menu Entrée numérique

Appuyer sur **INPUT** pour ouvrir.

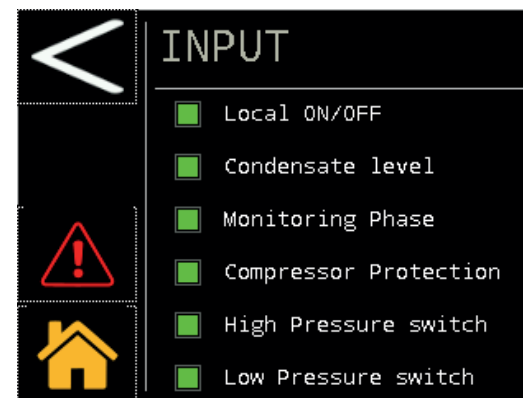
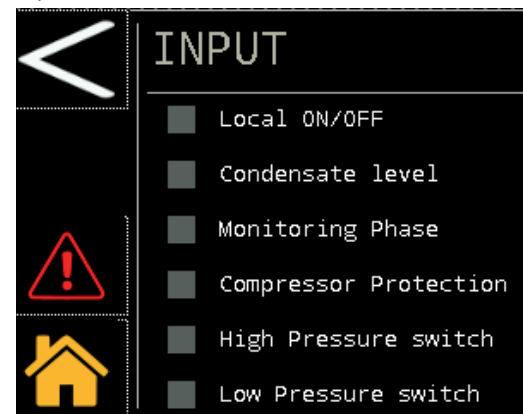

Local ON/OFF : vert si le contact de démarrage à distance est fermé, dans le cas contraire, il est gris.

Niveau de condensation : vert en présence de condensation sur le purgeur, dans le cas contraire, il est gris.

Phase de surveillance : vert si l'ordre des phases est correct, dans le cas contraire, il est gris.

Protection du compresseur : vert si la protection du compresseur est en position de fonctionnement normale, dans le cas contraire, il est gris.

Pressostat haute pression : vert si la protection du pressostat est en position de fonctionnement normale, dans le cas contraire, il est gris.

Pressostat basse pression : vert si la protection du pressostat est en position de fonctionnement normale, dans le cas contraire, il est gris.

6.2.5 Menu Sortie numérique

Appuyer sur **OUTPUT** pour ouvrir.

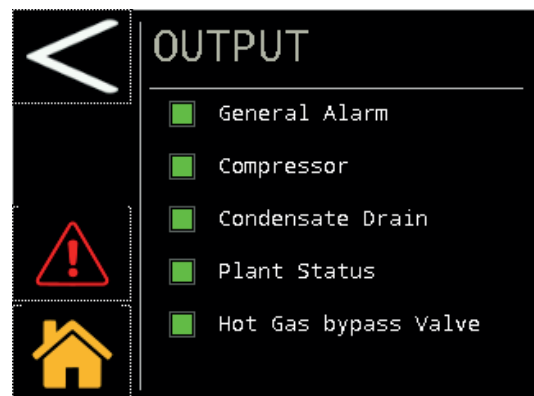
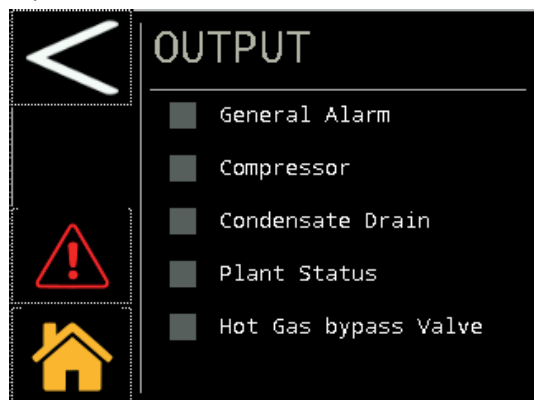

General alarm: green when general alarm contact is closed, otherwise it is gray.

Compressor: green when compressor start contact is closed, otherwise it is gray.

Condensate drain: green when condensate drain contact is closed, otherwise it is gray.

Plan Status: green when dryer on contact is closed, otherwise it is gray.

Hot gas bypass valve: green when bypass valve contact is closed (valve open), otherwise it is gray.

6.2.6 Menu Numéro de série

Appuyer sur **Serial Number** pour ouvrir.

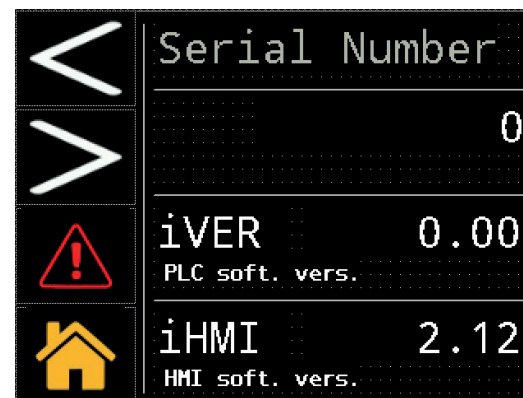

iVER: version de contrôle .

iHMI: version tactile

Ces données sont uniquement disponibles en mode lecture.





6.3 Menu Rapide

Ouvrir le menu en quelques étapes :



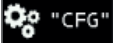

Modifier Date/Temps

Appuyer sur  → Appuyer sur  → Appuyer sur 



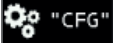

Modifier l'unité de mesure °C en °F

Appuyer sur  → Appuyer sur  → Appuyer sur  → Appuyer sur la case à droite et introduire le drapeau  pour changer et confirmer.

Modifier Local/rOFF

Appuyer sur  → Appuyer sur  → Appuyer sur  → Appuyer sur la case à droite et introduire le drapeau  pour changer et confirmer.

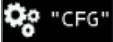



Alarme/avertissement

Appuyer sur  → Appuyer sur  → Appuyer sur  → Appuyer sur la case à droite et introduire le drapeau  pour changer et confirmer.

Default parameters

Appuyer sur  → Appuyer sur  → Appuyer sur  → Appuyer sur  → Appuyer sur la case à droite et introduire le drapeau  pour changer et confirmer.

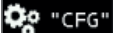

Modbus

Appuyer sur  → Appuyer sur  → Appuyer sur  → Appuyer sur  → Appuyer sur 

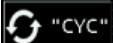

Afficher les capteurs

Touch  → Touch **PROBES**

Passer en mode Cycle

Appuyer sur  → Appuyer sur  → Appuyer sur  → Appuyer sur la case à droite et introduire le drapeau  pour changer et confirmer.

Changer le purgeur

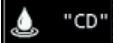
Appuyer sur  → Appuyer sur  → Appuyer sur  → Appuyer sur "0/1/2" pour effectuer la modification.

Afficher le numéro de série

Appuyer sur  → Appuyer sur **Serial Number**

Réinitialiser les alarmes

Rétablir les conditions nominales.

Appuyer sur  → Appuyer sur "Reset".

Historique des alarmes

Appuyer sur **ALARMS** → Appuyer sur  → Appuyer sur 

7 Entretien

• La machine est conçue et fabriquée pour garantir un fonctionnement continu ; toutefois, la durée de vie de ses composants est directement liée à l'entretien effectué.

•  Pour toute demande d'assistance ou de pièces détachées, identifier la machine en communiquant le modèle et le numéro de série figurant sur la plaque signalétique apposée à l'extérieur de l'appareil.

7.1 Recommandations générales

 Avant toute opération d'entretien, s'assurer que :

- le circuit d'air comprimé n'est plus sous pression ;
- que le sècheur soit débranché du réseau d'alimentation électrique.

 Utiliser toujours des pièces de rechange d'origine ; dans le cas contraire, le constructeur est déchargé de toute responsabilité pour le mauvais fonctionnement de la machine.

 En cas de fuite du réfrigérant, appeler un professionnel qualifié et agréé par le constructeur.

 La vanne ou valve Schrader ne doit être utilisée qu'en cas d'anomalie de fonctionnement de la machine : dans le cas contraire, les dommages causés par une charge de réfrigérant incorrecte ne seront pas reconnus au titre de la garantie.

7.2 Réfrigérant

Opération de charge : les dommages éventuels causés par une charge incorrecte de réfrigérant effectuée par un personnel non habilité ne seront pas reconnus au titre de la garantie. 















 L'appareil contient des gaz à effet de serre fluorés.

Le fluide frigorigène R513A à température et pression normales est un gaz incolore appartenant au SAFETY GROUP A1 - EN378 (fluide groupe 2 selon la directive PED 97/23/EC); GWP (Global Warming Potential) = 573.

 En cas de fuite de réfrigérant, aérer le local.

7.3 Programme d'entretien préventif

Pour une efficacité et une fiabilité maximales durables du sécheur, effectuer :



Description opération d'entretien	Périodicité d'entretien recommandée (conditions de fonctionnement standard)				
	Tous les jour	Toutes les semaines	Tous les 4 mois	Tous les 12 mois	Tous les 36 mois
<p style="text-align: center;">Opération</p> <p style="text-align: center;">contrôler  Service </p>					
Contrôler que le témoin POWER ON est allumé					
Contrôler les indicateurs du tableau des commandes.					
Contrôler le purgeur des condensats.					
Nettoyer les ailettes du condenseur					
Contrôler le positionnement et le fonctionnement correct de la résistance carter.					
Contrôler la consommation électrique.					
Contrôler les fuites de réfrigérant.					
Dépressurisation de l'installation. Effectuer l'entretien du purgeur.					
Dépressurisation de l'installation. Remplacer les éléments du préfiltre et du post-filtre.					
Contrôler les sondes de température. Remplacer si nécessaire.				 	
Kit d'entretien séchoir.					

Sont disponibles (voir paragraphe 9.4) :

- a) Kits d'entretien préventif 3 ans ;
- b) Kits d'entretien
 - kits compresseur ;
 - kits ventilateur ;
 - Kits soupape à gaz chaud;
 - Kits condenseur d'eau ;
- c) pièces détachées.

7.4 Mise au rebut

Le fluide frigorigène et le lubrifiant (huile) contenus dans le circuit devront être récupérés selon la législation antipollution.

	Recyclage Élimination 
charpenterie (ossature)	acier/résines époxy-polyester
échangeur	aluminium
tuyauteries/collecteurs	cuivre/aluminium/acier au carbone
purgeur	polyamide
isolation échangeur	EPS (polystyrène fritté)
isolation tuyauteries	caoutchouc synthétique
compresseur	acier/cuivre/aluminium/huile
condenseur	cuivre/aluminium
réfrigérant	R513A
valves ou vannes	laiton
câbles électriques	cuivre/PVC

Les équipements contenant des composants électriques doivent être éliminés séparément avec les déchets électriques et électroniques conformément à la législation locale et en vigueur.

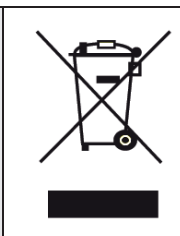

8 Dépannage

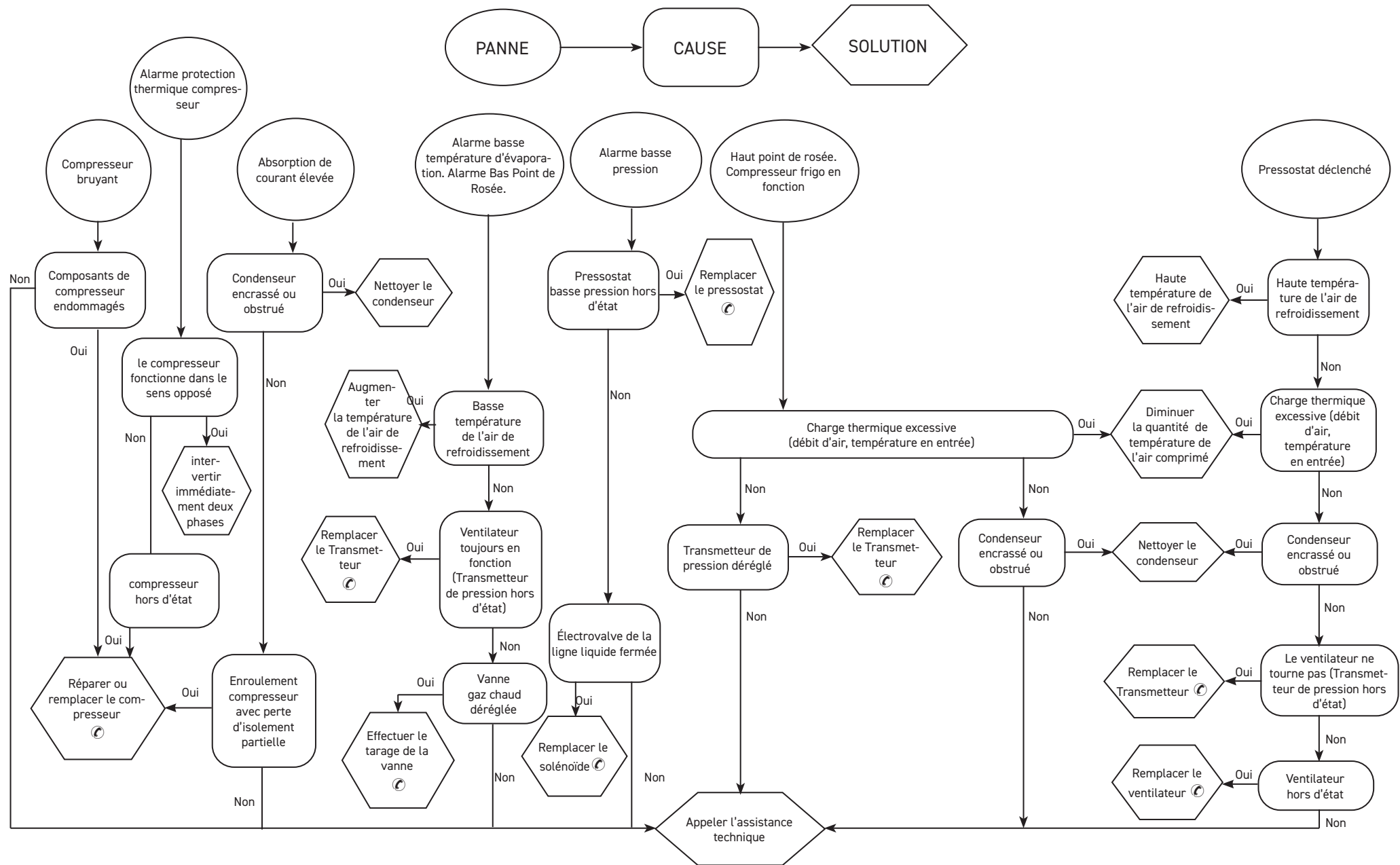

Appendix
Apéndice
Appendice

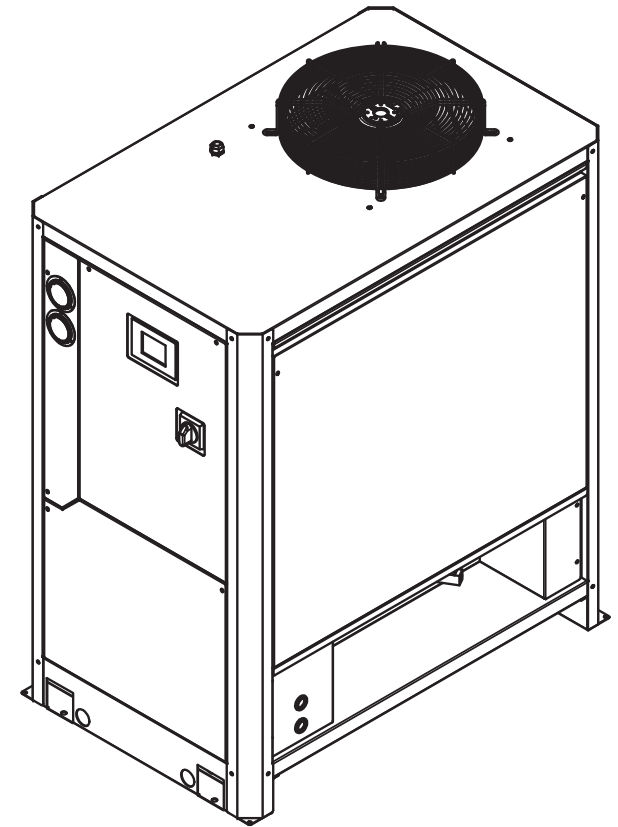
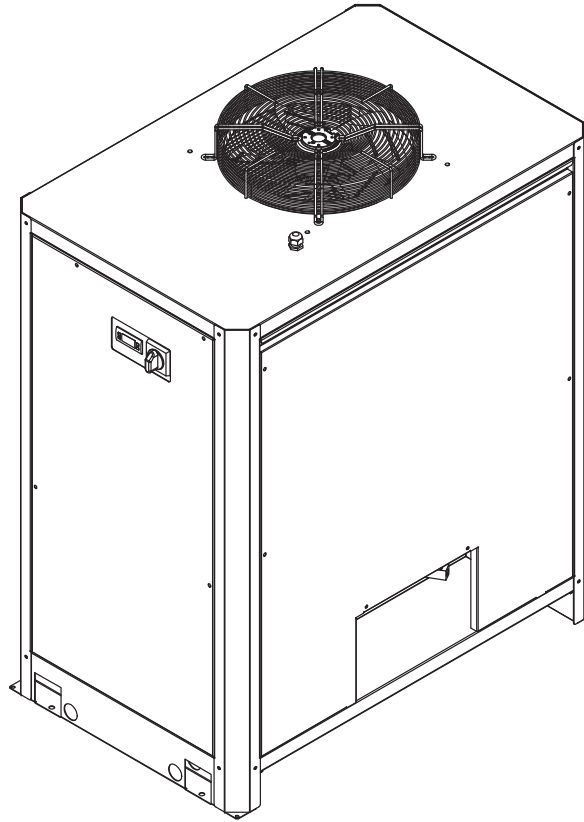

Contents

9.1 LEGEND	2
9.2 INSTALLATION DIAGRAM	4
9.3 TECHNICAL DATA	5
9.4 SPARE PARTS	6
9.5 EXPLODED DRAWING PSE325/500 Ac	8
EXPLODED DRAWING PSE700/800 Ac	9
EXPLODED DRAWING PSE 1000 Wc	10
9.6 DIMENSIONAL DRAWING PST325-500 Ac	11
DIMENSIONAL DRAWING PSE 700-1000 Ac	12
DIMENSIONAL DRAWING PSE 700-1000 Wc	13
9.7 REFRIGERANT CIRCUIT (PSE325-500) Ac	14
REFRIGERANT CIRCUIT (PSE700-1000) Ac	15
REFRIGERANT CIRCUIT (PSE700-1000) Wc	16
9.8 WIRING DIAGRAM PSE325-500	17
WIRING DIAGRAM PSE 700-1000 (touch)	24

9.1 LEGEND

Symbol	/EN/ES/FR	Symbol	/EN/ES/FR	Symbol	/EN/ES/FR
	Weight / Peso/ Poids /	▲ ▲ ▲	/ Cooling air outlet / Salida aire de enfriamiento / Sortie air de refroidissement	⑰	/ Hot gas solenoid valve / Electroválvula gas caliente / Électrovanne gaz chaud
	/ Ambient temperature / Temperatura ambiente / Température Ambiente	△ △ △	/ Cooling air inlet / Entrada aire de enfriamiento / Entrée air de refroidissement	⑱	/ Water pressostatic valve / Válvula presostática agua / Valve presostatique eau
	/ During transport and stockage / Durante transporte y almacenaje / Pendant le transport et le stockage		/ General alarm / Alarma general / Alarme générale	-	/ Panels / Paneles / Panneaux
	/ After installation / Después de la instalación / Après l'installation	----	/ Optional / Opcional / Option	A1	/ Control Card / Tarjeta electrónica / Carte électronique
	/ Air-side max. working pressure / Presión máxima de trabajo lado aire / Pression maximum d'utilisation côté air	①	/ Compressor / Compresor / Compresseur	A2	/ Serial card / Tarjeta serie / Carte série
	/ Compressed air inlet temperature / Temperatura entrada aire comprimido / Température entrée air comprimé	MC	/ Refrigerant condenser / Condensador refrigerante / Condenseur réfrigérant	AI	/ Analog Inputs / Entradas analógicas / Entrées analogiques
0	/ Minimum cable size for electrical connection. / Sección mínima cable homologado para conexionado Eléctrico / Section minimale câble homologué pour le raccordement électrique.	②	/ Refrigerant filter / Filtro refrigerante / Filtre réfrigérant	B0	/ Dew point temperature sensor / Sensor temperatura punto rocío / Capteur de température dew point
	/ Compressed air inlet / Entrada aire comprimido / Entrée air comprimé	③	/ Fan motor / Electroventilador / Électroventilateur	B3	/ Ambient temperature sensor
	/ Compressed air outlet / Salida aire comprimido / Sortie air comprimé	EV	/ Refrigerant filter / Filtro refrigerante / Filtre réfrigérant	B2	/ Evaporation temperature sensor / Sensor temperatura evaporación / Capteur de température évaporation
	/ Cooling water inlet / Entrada agua de enfriamiento / Entrée eau de refroidissement	④	/ Expansion capillary / Capillar expansión / Tubo de détente	B8	/ Discharge temperature sensor / Sensor temperatura salida refrigerante / Capteur de température départ réfrigérant
	/ Cooling water outlet / Salida agua de enfriamiento / Sortie eau de refroidissement	⑤	/ Liquid line solenoid valve / Electroválvula línea de líquido / Electrovanne ligne de liquide	CS1	/ Condensate level sensor / Sensor de nivel / Capteur de niveau
	/ Calibration values / Valores de calibración / Valeurs de réglage	⑥	/ Evaporator / Evaporador / Évaporateur	EH1	/ Crankcase heater / Resistencia cárter / Résistance carter
	/ Electrical supply inlet / Entrada alimentación eléctrica / Entrée alimentation électrique	⑦	/ Pressure point / Toma de presión / Prise de pression	FA1	/ Control card fuse / Fusible tarjeta electrónica / Fusible carte électronique
	/ Condensate drain / Drenaje de condensados / Purge des condensats	⑧	/ Low pressure switch / Presostato baja presión / Pressostat basse pression	FU1-7	/ Fuses / Fusibles / Fusibles
----	/ Limit of equipment / Límite del equipo / Limite de l'appareil	⑨	/ Hot gas valve / Válvula gas caliente / Vanne gas valve	DI	/ Digital Inputs / Entradas digitales / Entrées numériques
	/ Sound pressure level (1m distance in free field - according to ISO 3746). / Nivel de presión sonora (a 1 m de distancia en campo libre, según norma ISO 3746) / Niveau de pression sonore à 1 mètre de distance en champ libre (selon norme ISO 3746)	⑪	/ Pressure pressure transmitter (fan) / Presostato ventilador / Presostat ventilateur	KA1	/ High pressure alarm relay / Relé alarma presostato alta presión / Relais alarme pressostat haute pression
		LP	/ High pressure switch / Presostato alta presión / Pressostat haute pression	KM1	/ Compressor contactor / Contactor compresor / Contacteur compresseur
		⑫	/ Condensate drain valve / Grifo drenaje condensados / Robinet décharge condensats	KM2	/ Fan contactor / Contactor ventilador / Contacteur ventilateur
		⑬	/ Condensate filter valve / Filtro drenaje condensados / Filtre décharge condensats	QF	/ Residual-current automatic circuit breaker / Interruptor magnético diferencial / Interrupteur magnéto-thermique différentiel
		HP	/ Condensate drain solenoid valve / Electroválvula drenaje condensados / Electrovanne décharge condensats / Şıkıdruma separators	QF1	/ automatic switch / Interruptor automático / Interrup. automatique
		⑮		QS1	/ Main power switch / Interruptor general / Interrupteur général
		⑯		RO	/ Remote Off / Apagado remoto / Def remoto
		⑰		SL	/ Serial line / Línea serie / Liaison série

9.1 LEGEND

Symbol	/EN/ES/FR
TC1	/ Auxiliary transformer / Transformador auxiliares / Transformateur auxiliaires
DO	/ Digital Outputs / Salidas digitales / Sorties numériques
X1-X5	/ Terminal blocks / Borneras / Boîtes à bornes
(#)	Components for models with TIMED drain. For other external drains, consult the constructor's manual. Componentes presentes en el modelo con sistema de drenaje TEMPORIZADO. Para los dispositivos de drenaje externos, consulte el manual de fábrica respectivo. Composants présents dans les modèles avec purgeur temporisé. Pour d'autres purgeurs externes, consulter la notice spécifique du constructeur.

9.2 INSTALLATION DIAGRAM

1	2	3	4
Air compressor Compresor de aire Compresseur d'air	Dryer Secador Sécheur	By-pass Grupo by-pass Groupe by-pass	Filter [3 micron filtration or better] near dryer air inlet Filtro (filtración de 3 micrones o mejor) cerca de la entrada de aire de la secadora Filtre (filtration des particules de 3 microns minimum) à proximité de l'orifice d'admission d'air du sécheur

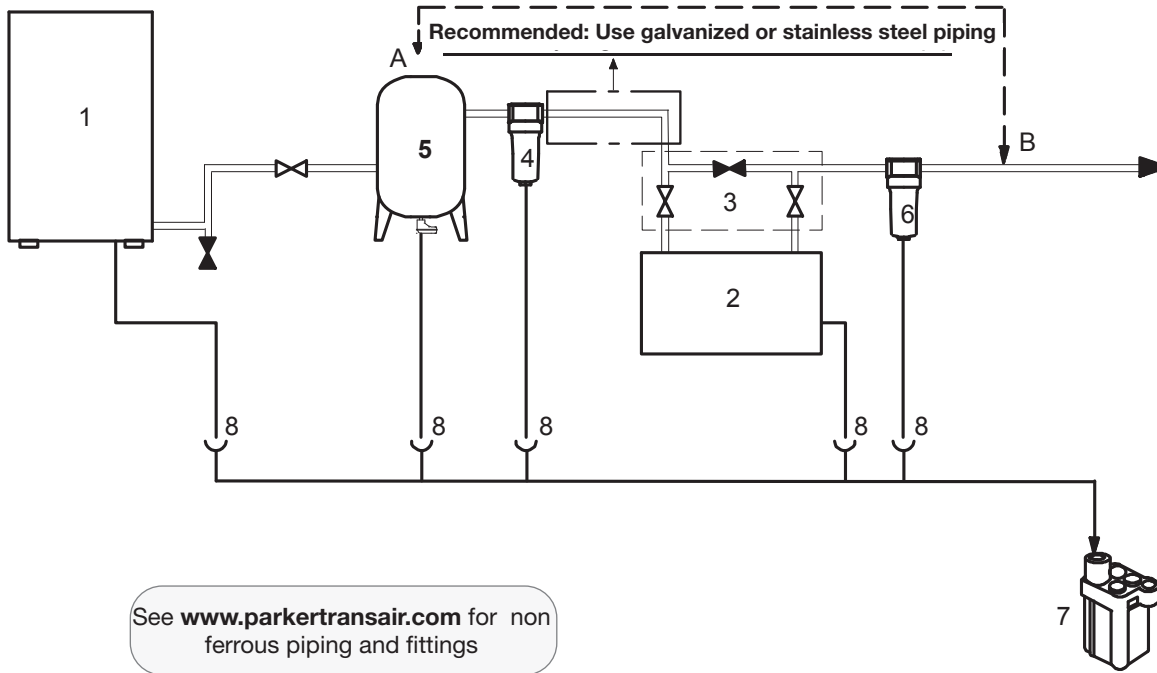







Safety relief valves should not exceed dryer design pressure
Válvulas de seguridad para no superar la presión de diseño del secador
Soupapes de sécurité, pour ne pas dépasser la pression préétablie du sécheur





Use flexible hoses for air connections if the compressed air system is subject to vibration
Tubos flexibles para las conexiones de aire si la red está expuesta a vibraciones
Tuyaux flexibles pour raccordements de l'air si le réseau est soumis à des vibrations

5	6	7	8
Tank in position A or in B Depósito en la posición A o B Réservoir en position A ou B	Outlet filter Filtro de salida Filtre en sortie	Oil-Water separator Separador agua-aceite Séparateur eau-huile	Condensate drain Drenaje de condensados Purgeur des condensats

Use pulsation dampers if compressed air system is subject to pulsation
Amortiguadores si la red está expuesta a pulsaciones
Amortisseurs hydrauliques appropriés si le réseau est soumis à des pulsations

9.3 TECHNICAL DATA

Model	Weight  Kg	Refrigerant R513A				N° of coolers	MIN.- MAX Ambient Temperature  Amb		Compressed air inlet Temperature  In	F.L.A.[A] 460V±10%/ 3Ph/60Hz	MOP	MCA	IP	Minimum cable size for electrical connection	Sound pressure level 
		Ac		Wc			During transport and stockage 	After installation 		60Hz					
	Kg	Kg	CO ₂ e (t)	Kg	CO ₂ e (t)	N°			A	A	A	-	∅ [mm ²]	[dB (A)]	
PSE 325	205	1.6	0.92	-	-	1	32-122°F (0-50°C)	41-122°F (5-50°C)	41-149°F (5-65°C)	6.6	10	8.5	44	4G14AWG	<75
PSE 400	205	1.6	0.92	-	-					6.9	10	8.5			
PSE 500	210	1,3	0,75	-	-					9.45	15	11.5			
PSE 700	260	2.2	1.27	3.0	1.72					10.7	20	13	54		
PSE 800	262	2.0	1.09	2.8	1.61						20	13			
PSE 1000	264	2,1	1.21	3.0	1.72						20	13			

Calibration values 	Hot gas valve 12 - HGV	Pressure condensation	High pressure Switch 13-HP	Low pressure Switch 9-LP	Operating Pressure Max 	Water pressostatic valve 3-WPV	Compressed air inlet/outlet 	Cooling water inlet/outlet 	Condensate drain 
									BSP-F
PSE 325/500	35-38 psi 2.4-2.6 bar	116-159.5psi 8-11 bar	290psi 20 bar	14.5-29psi 1.0-2.0 bar	203psi 14 bar	-	2" NPT-F	-	1/2"
PSE 700/800						145-160 psi 10-11 bar	3" NPT-M	1/2" NPT-F	
PSE 1000						145-160 psi 10-11 bar	3" NPT-M	3/4" NPT-F	

P.T. = Plate type exchanger; S&T= Shell and tube exchanger

9.4 SPARE PARTS

COMPONENTS		See par. 8.5	PSE 325	PSE 400	PSE 500	PSE 700	PSE 800	PSE 1000
3 years preventive maintenance kits	Ac	⑪ ⑬ ⑮ B0 B2 B8 CS1	398H473756					
Electrical Kit	Ac/Wc	-	398H473758					
Compressor kit	Ac/Wc	① ④ KM1	398H473760		398H473761	398H473762	398H473763	398H473764
Fan kit	Ac	③ KM2	398H473042			398H473773		
Hot gas valve kit	Ac	④ ⑫	398H473777				398H473778	
Refrigerant condenser	Ac	②	ET-398H114848					
Shell & tube exchanger	Wc	②.2	-			ET-398H186194	ET-398H186234	
Refrigerant filter	Ac/Wc	④	398H206226					
Liquid line solenoid valve	Ac/Wc	⑤	ET-398H183148					
Water - air exchanger / Separator / Air-air exchanger	Ac/Wc	⑦	398H473066		398H473067	398H473068		
Pressure gauge	Ac	⑩ ⑭	-			ET-398H354042		
Low pressure switch	Ac/WC	⑪	ET-398H474521					
High pressure switch	Ac/Wc	⑬	ET-398H474520					
High pressure transmitter	Ac	⑮	ET-398H275311					
hot gas solenoid valve	Ac/Wc	⑰	ET-398H183148					
Pressostatic valve	Wc P.T.	⑳.1	-			398H378202		398H378209
	Wc S&T	⑳.2				398H378201		398H378202
Electronic card SMP5500	Ac/Wc	A1	398H473784			-		

9.4 SPARE PARTS

COMPONENTS		See par. 8.5	PSE 325	PSE 400	PSE 500	PSE 700	PSE 800	PSE 1000
Electronic card touch AVC6200	Ac/Wc	A1		-			398H473785	
Expansion EVE6000	Ac/Wc	-		-			398H473786	
Display touch	Ac	-		-			398H473787	
	Wc	-		-			398H473787Y001	
Dew point/ evaporator temperature sensor (3m)	Ac	B0			398H275894			
Evaporation temperature sensor (3m)	Ac	B2			398H275894			
Discharge temperature sensor (1,5m)	Ac	B8			ET-398H275973			
Condensate level sensor	Ac	CS3			398H275752			
Phases monitor	Ac	A4			398H256366			
Main disconnect switch	Ac/Wc	QS1			398H256418			
Compressor Automatic switch	Ac/Wc	QF1			398H256291			
Compressor contactor	Ac/Wc	KM1			398H256248			
Fan contactor	Ac	KM2			398H256243			
Auxiliary transformer	Ac/Wc	TC1			ET-398H255853			
Condensate Drain solenoid valve	Ac	16-17-18			398H698218			

9.5 EXPLODED DRAWING PSE325/500 Ac

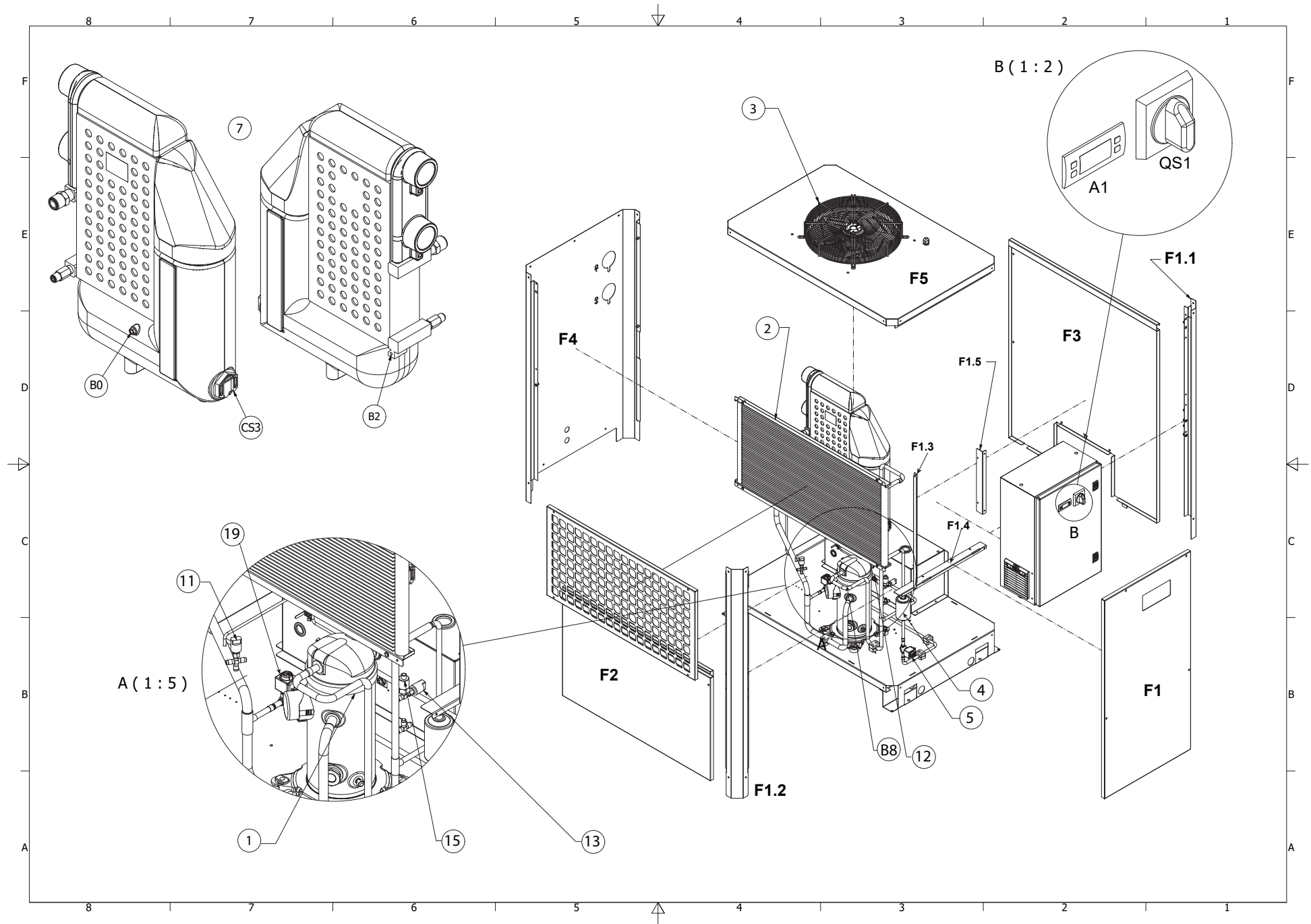

EXPLODED DRAWING PSE700/1000 Ac

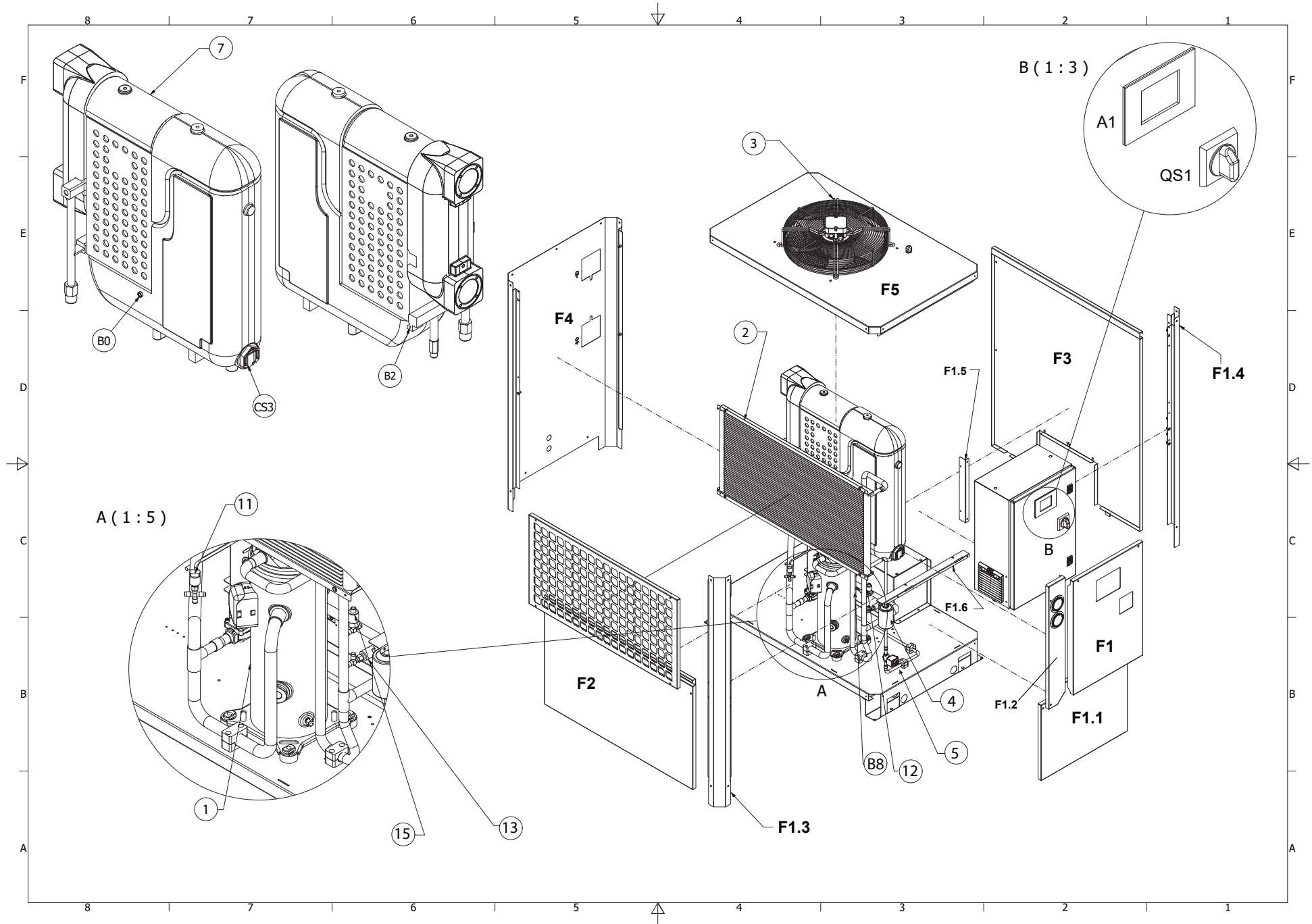

EXPLODED DRAWING PSE 1000 Wc

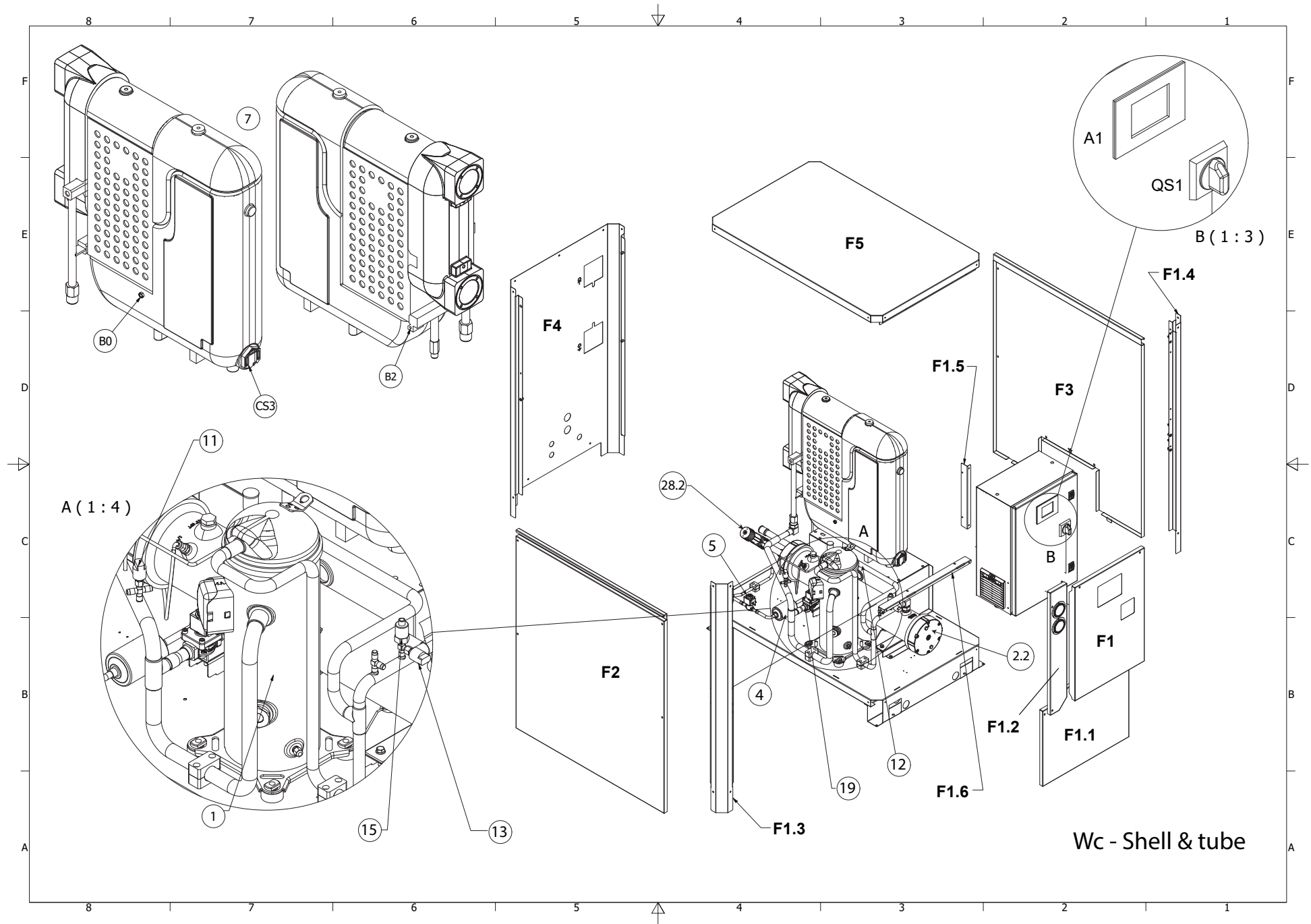

9.6 DIMENSIONAL DRAWING PST325-500 Ac

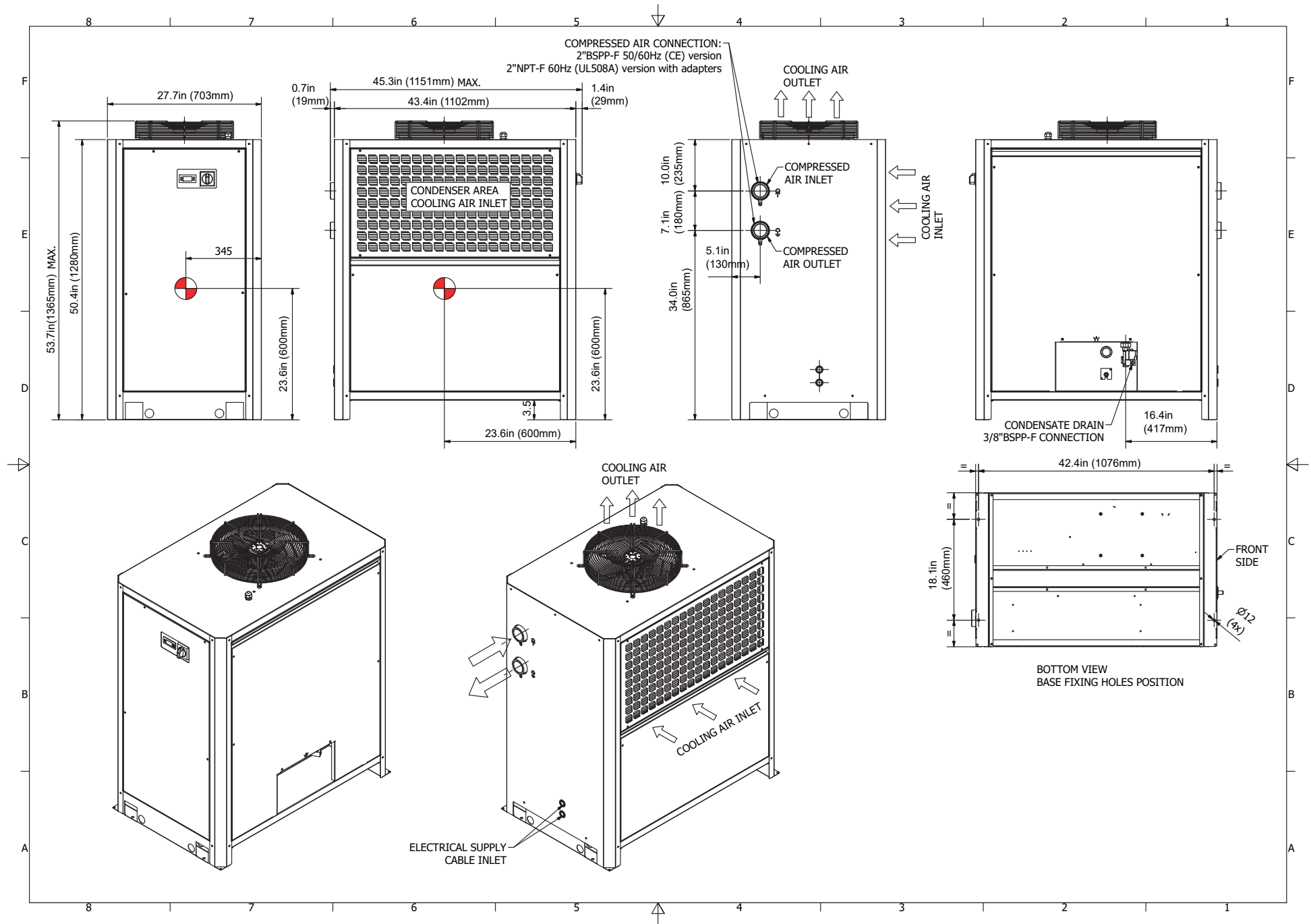

DIMENSIONAL DRAWING PSE 700-1000 Ac

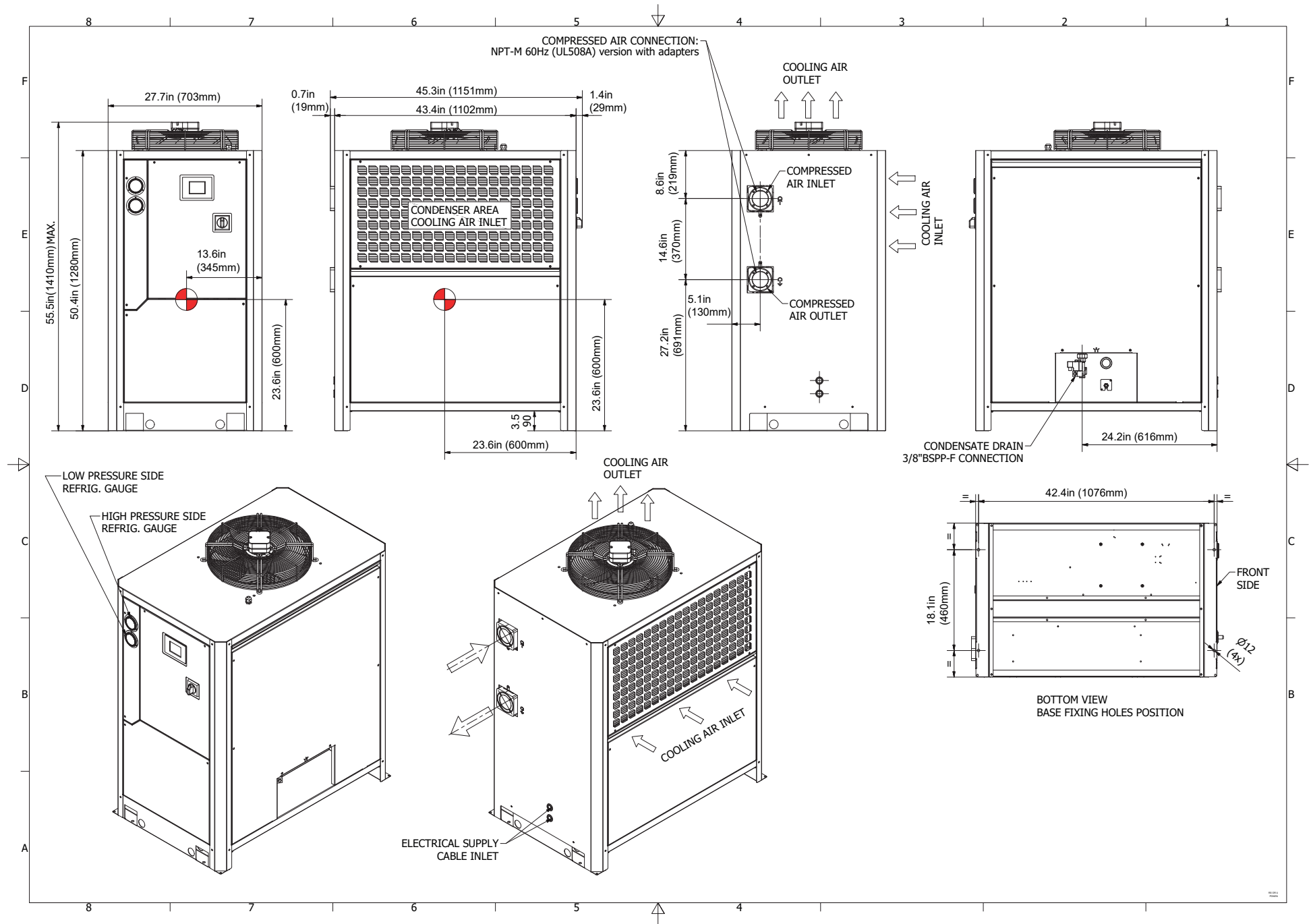

DIMENSIONAL DRAWING PSE 700-1000 Wc

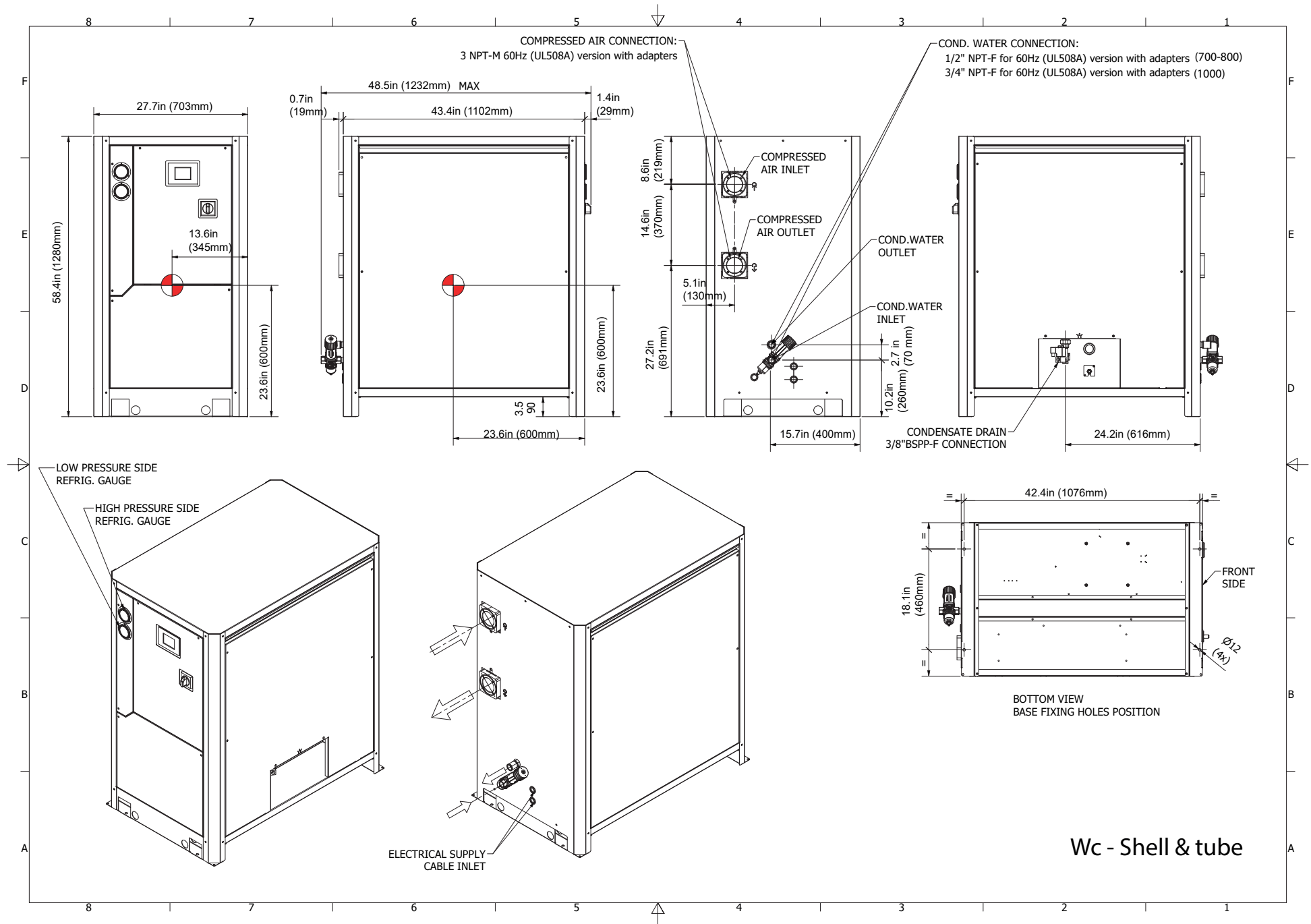

Wc - Shell & tube

9.7 REFRIGERANT CIRCUIT PSE325-500 Ac

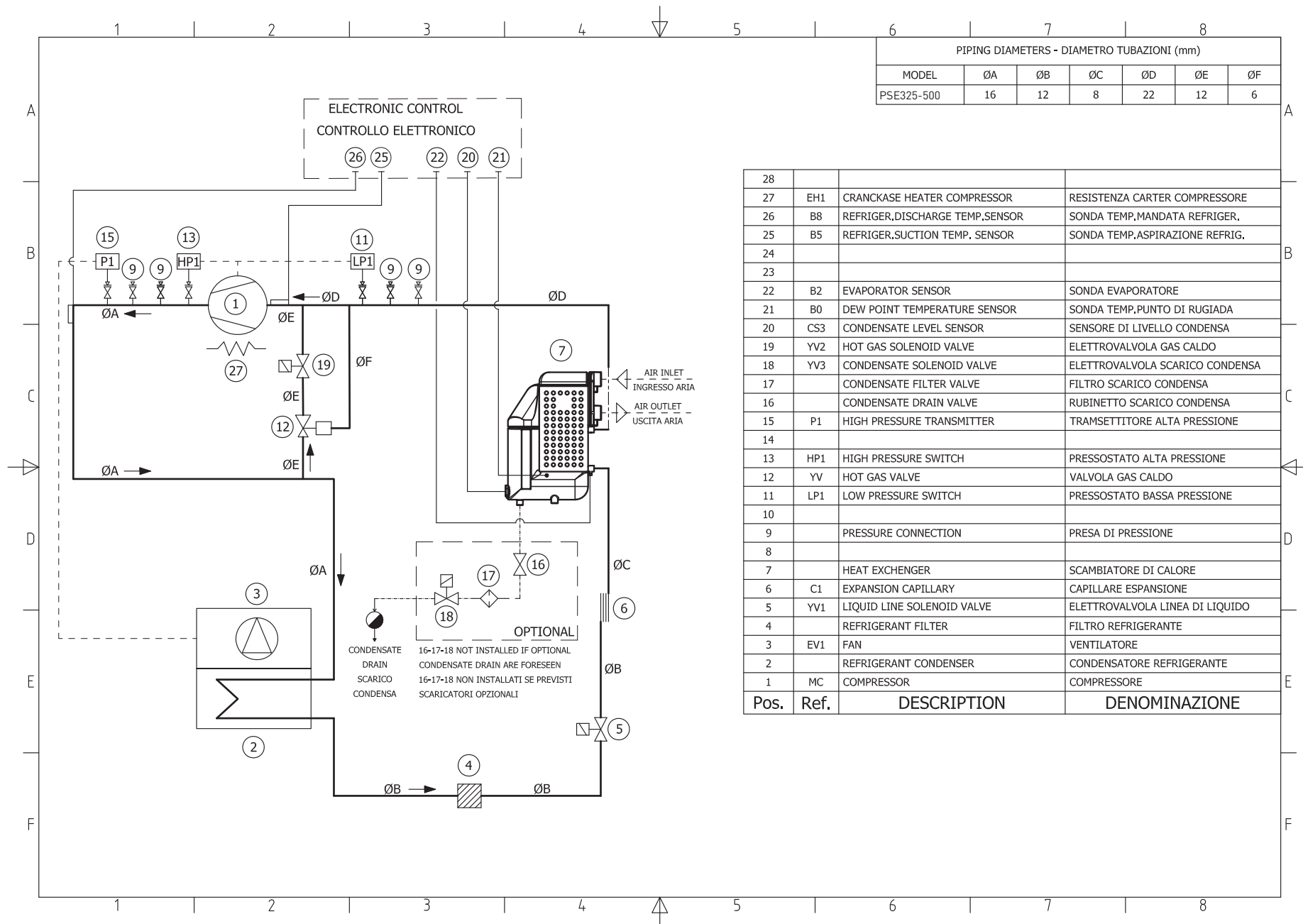

REFRIGERANT CIRCUIT PSE700-1000 Ac

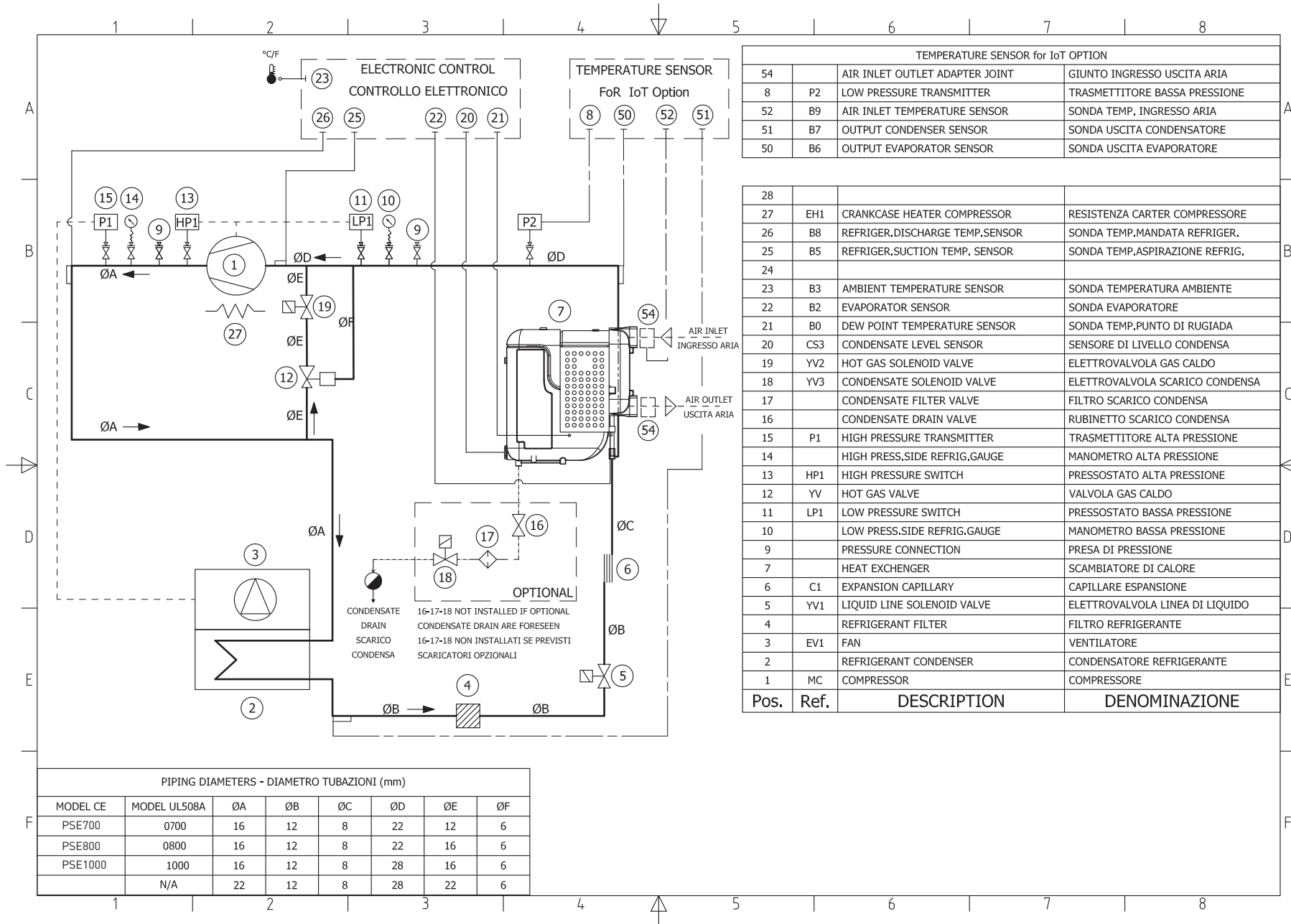

TEMPERATURE SENSOR for IoT OPTION			
54		AIR INLET OUTLET ADAPTER JOINT	GIUNTO INGRESSO USCITA ARIA
8	P2	LOW PRESSURE TRANSMITTER	TRASMETTITORE BASSA PRESSIONE
52	B9	AIR INLET TEMPERATURE SENSOR	SONDA TEMP, INGRESSO ARIA
51	B7	OUTPUT CONDENSER SENSOR	SONDA USCITA CONDENSATORE
50	B6	OUTPUT EVAPORATOR SENSOR	SONDA USCITA EVAPORATORE

28			
27	EH1	CRANKCASE HEATER COMPRESSOR	RESISTENZA CARTER COMPRESSORE
26	B8	REFRIGER.DISCHARGE TEMP.SENSOR	SONDA TEMP,MANDATA REFRIGER.
25	B5	REFRIGER.SUCTION TEMP. SENSOR	SONDA TEMP,ASPIRAZIONE REFRIG.
24			
23	B3	AMBIENT TEMPERATURE SENSOR	SONDA TEMPERATURA AMBIENTE
22	B2	EVAPORATOR SENSOR	SONDA EVAPORATORE
21	B0	DEW POINT TEMPERATURE SENSOR	SONDA TEMP,PUNTO DI RUGIADA
20	CS3	CONDENSATE LEVEL SENSOR	SENSORE DI LIVELLO CONDENSA
19	YV2	HOT GAS SOLENOID VALVE	ELETTROVALVOLA GAS CALDO
18	YV3	CONDENSATE SOLENOID VALVE	ELETTROVALVOLA SCARICO CONDENSA
17		CONDENSATE FILTER VALVE	FILTRO SCARICO CONDENSA
16		CONDENSATE DRAIN VALVE	RUBINETTO SCARICO CONDENSA
15	P1	HIGH PRESSURE TRANSMITTER	TRASMETTITORE ALTA PRESSIONE
14		HIGH PRESS.SIDE REFRIG,GAUGE	MANOMETRO ALTA PRESSIONE
13	HP1	HIGH PRESSURE SWITCH	PRESSOSTATO ALTA PRESSIONE
12	YV	HOT GAS VALVE	VALVOLA GAS CALDO
11	LP1	LOW PRESSURE SWITCH	PRESSOSTATO BASSA PRESSIONE
10		LOW PRESS.SIDE REFRIG,GAUGE	MANOMETRO BASSA PRESSIONE
9		PRESSURE CONNECTION	PRESA DI PRESSIONE
7		HEAT EXCHENGER	SCAMBIATORE DI CALORE
6	C1	EXPANSION CAPILLARY	CAPILLARE ESPANSIONE
5	YV1	LIQUID LINE SOLENOID VALVE	ELETTROVALVOLA LINEA DI LIQUIDO
4		REFRIGERANT FILTER	FILTRO REFRIGERANTE
3	EV1	FAN	VENTILATORE
2		REFRIGERANT CONDENSER	CONDENSATORE REFRIGERANTE
1	MC	COMPRESSOR	COMPRESSORE
Pos.	Ref.	DESCRIPTION	DENOMINAZIONE

PIPING DIAMETERS - DIAMETRO TUBAZIONI (mm)							
MODEL CE	MODEL UL508A	ØA	ØB	ØC	ØD	ØE	ØF
PSE700	0700	16	12	8	22	12	6
PSE800	0800	16	12	8	22	16	6
PSE1000	1000	16	12	8	28	16	6
	N/A	22	12	8	28	22	6

REFRIGERANT CIRCUIT (PSE700-1000) Wc

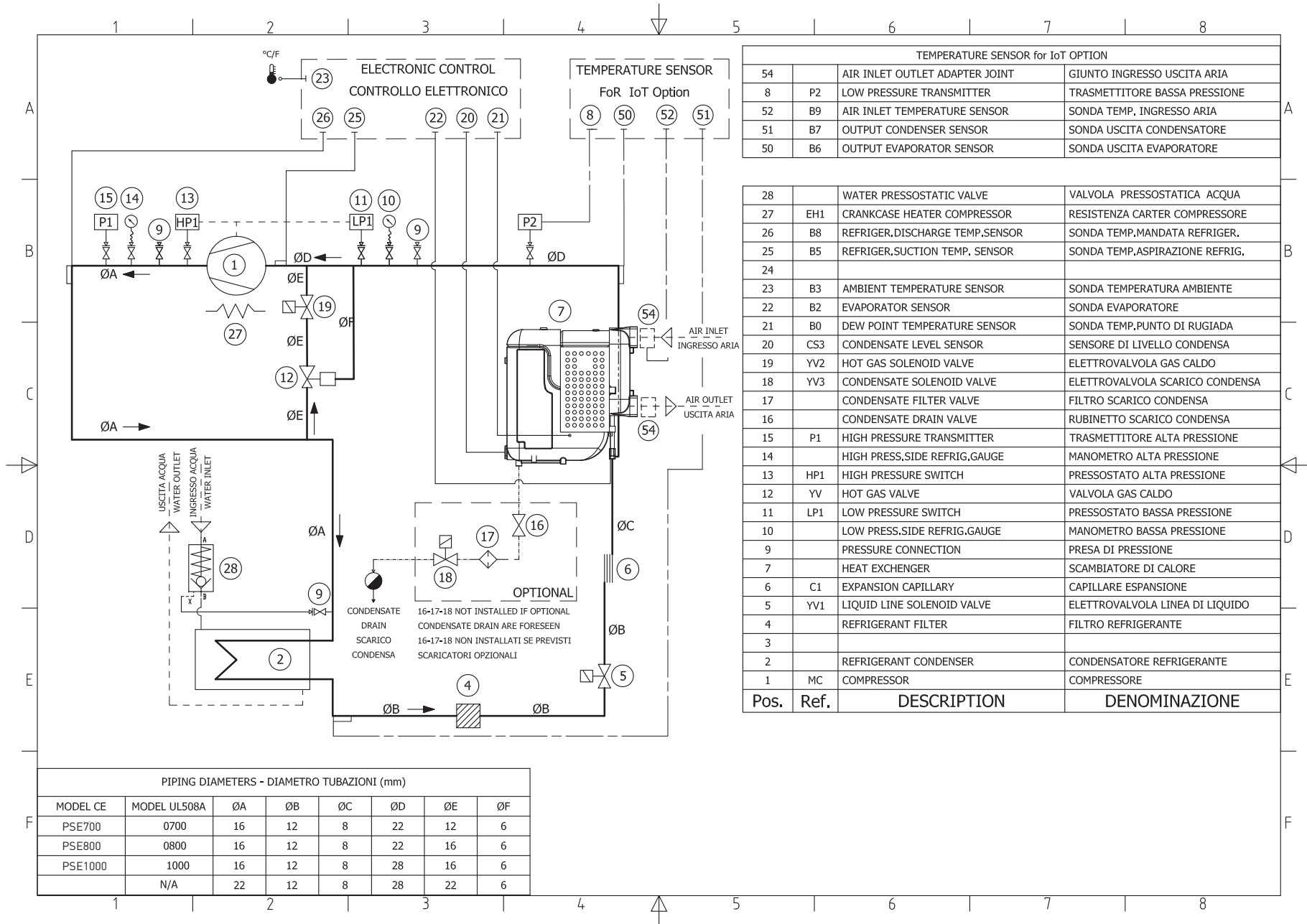

PIPING DIAMETERS - DIAMETRO TUBAZIONI (mm)

MODEL CE	MODEL UL508A	ØA	ØB	ØC	ØD	ØE	ØF
PSE700	0700	16	12	8	22	12	6
PSE800	0800	16	12	8	22	16	6
PSE1000	1000	16	12	8	28	16	6
	N/A	22	12	8	28	22	6

DRYER SIZE	COMPRESSOR					FAN MOTOR					CRANKCASE HEATER				AUXILIARY		
	TAG	FLA [A]	Pn		LRA [A]	TAG	FLA [A]	Pn		LRA [A]	TAG	Pn		FLA [A]	Pn [A]		FLA [A]
			kW	Hp				kW	Hp			kW	Hp		kW	Hp	
120 (325)	MA1	6,1	3,2	4	45	MA3	0,44	0,2	1/3	3,5	EH11	0,040	--	0,08	0,3	--	0,9
140 (400)			4	5 1/2													
180 (500)		6,4	4	5 1/2													

GENERAL DATA / DONNÉES GÉNÉRALES			
DRYER SIZE	120	140	180
Pn [kW]	3,5		4,2
FLA [A]	6,6		6,9
MCA [A]	8,5		8,5
MOP [A]	15		

ITEM	398H316915
Supply Voltage Tension d'alimentation	460V - 3Ph - 60Hz
Control Voltage Tension auxiliaire	24Vac / 24Vdc
Enclosed type	TYPE 1
Residual current switch and fuses Disjoncteur et fusibles à courant résiduel	RCCB Id 0.3A class A and Fuses CC / J
SCCR 120-180 SCCR (325-500)	5 kA
Grounding Mise à la terre	Solidly grounded
Additional Opzioni	/

SH	DESCRIPTION	DESCRIPTION
1	Electrical data	Données techniques
2	Electrical data	Données techniques
3	Power circuits	Circuit de puissance
4	Auxiliary circuits	Circuit auxiliaire
5	Auxiliary circuits	Circuit auxiliaire
6	Auxiliary circuits	Circuit auxiliaire
7	Customer interface	Interface client
8	Terminal block	Bornier
9	Electrical panel layout	Plan du panneau électrique
10	Component list	Liste des composants
11	Component list	Liste des composants
12	Fuses list	Liste des fusibles
13	On machine	Sur machine
14	Cables list	Liste des câbles
15	Cabinet	Charpenterie

ELECTRICAL SUPPLY LINE - LINEA ALIMENTAZIONE 460/3Ph/60Hz
CABLES SIZE - DIMENSIONI CAVI SEE TABLE (MCA) - VEDERE TABELLA (MCA)

	1	2	3	4	5	6	7	8																																																																																																																																																							
A	<table border="1"> <tr> <th>NFPA</th> <th>IEC</th> <th>DESCRIZIONE</th> </tr> <tr> <td> DS</td> <td> OS</td> <td>GENERAL SWITCH DÉBRANCHEUR PRINCIPAL</td> </tr> <tr> <td> CB</td> <td> OM</td> <td>AUTOMATIC THERMAL SWITCH INTERRUPTEUR THERMIQUE AUTOMATIQUE</td> </tr> <tr> <td> M</td> <td> KM</td> <td>COMPRESSOR CONTACT CONTACT COMPRESSEUR</td> </tr> </table>	NFPA	IEC	DESCRIZIONE	DS	OS	GENERAL SWITCH DÉBRANCHEUR PRINCIPAL	CB	OM	AUTOMATIC THERMAL SWITCH INTERRUPTEUR THERMIQUE AUTOMATIQUE	M	KM	COMPRESSOR CONTACT CONTACT COMPRESSEUR	<table border="1"> <tr> <th>NFPA</th> <th>IEC</th> <th>DESCRIZIONE</th> </tr> <tr> <td> OM</td> <td> OM</td> <td>AUTOMATIC SWITCH SWITCH AUTOMATIQUE</td> </tr> <tr> <td> FV</td> <td> FV</td> <td>PHASE MONITORING RELAY RELAIS DE SURVEILLANCE DE PHASE</td> </tr> <tr> <td> FV</td> <td> FV</td> <td>PHASE MONITORING RELAY RELAIS DE SURVEILLANCE DE PHASE</td> </tr> </table>	NFPA	IEC	DESCRIZIONE	OM	OM	AUTOMATIC SWITCH SWITCH AUTOMATIQUE	FV	FV	PHASE MONITORING RELAY RELAIS DE SURVEILLANCE DE PHASE	FV	FV	PHASE MONITORING RELAY RELAIS DE SURVEILLANCE DE PHASE	<table border="1"> <tr> <th colspan="3">Tightening Torque - Serrage du couple</th> </tr> <tr> <th></th> <th>Nm</th> <th>In*Lb</th> </tr> <tr> <td>QS1</td> <td>6</td> <td>53,1</td> </tr> <tr> <td>QM1</td> <td>1,7</td> <td>15,0</td> </tr> <tr> <td>QM1(aux)</td> <td>1</td> <td>8,9</td> </tr> <tr> <td>TM1</td> <td>0,6</td> <td>5,3</td> </tr> <tr> <td>KM1</td> <td>3,2</td> <td>28,9</td> </tr> <tr> <td>KM1(aux)</td> <td>1,2</td> <td>10,6</td> </tr> <tr> <td>KM3</td> <td>1,2</td> <td>10,6</td> </tr> <tr> <td>KM3(aux)</td> <td>1,2</td> <td>10,6</td> </tr> <tr> <td>E0</td> <td>6</td> <td>53,1</td> </tr> <tr> <td>fu(10,3X38)</td> <td>2,3</td> <td>20,4</td> </tr> <tr> <td>fu(5X20)</td> <td>0,5</td> <td>4,4</td> </tr> <tr> <td>FV6</td> <td>0,8</td> <td>7,1</td> </tr> <tr> <td>A1,A2,A3(in)</td> <td>0,2</td> <td>1,8</td> </tr> <tr> <td>A1,A2,A3(out)</td> <td>0,6</td> <td>5,3</td> </tr> </table>	Tightening Torque - Serrage du couple				Nm	In*Lb	QS1	6	53,1	QM1	1,7	15,0	QM1(aux)	1	8,9	TM1	0,6	5,3	KM1	3,2	28,9	KM1(aux)	1,2	10,6	KM3	1,2	10,6	KM3(aux)	1,2	10,6	E0	6	53,1	fu(10,3X38)	2,3	20,4	fu(5X20)	0,5	4,4	FV6	0,8	7,1	A1,A2,A3(in)	0,2	1,8	A1,A2,A3(out)	0,6	5,3	<table border="1"> <tr> <th colspan="3">Designation Color in according to UL508A Colour Abbreviations in according to IEC 60757</th> </tr> <tr> <th>WIRING</th> <th>COLOR</th> <th>CROSS SECTION</th> </tr> <tr> <td>Power circuit Circuito di Potenza</td> <td>BLACK - BK</td> <td rowspan="6">as circuit diagram indication</td> </tr> <tr> <td>Control line at 230-24Vac Linea di Controllo a 230-24Vac</td> <td>RED - RD</td> </tr> <tr> <td>Control line at 24Vdc Linea di Controllo a 24Vdc</td> <td>DARK BLUE - DBU</td> </tr> <tr> <td rowspan="3">Analog signal Segnali Analogici</td> <td>WHITE - WH</td> </tr> <tr> <td>VIOLET - VT</td> </tr> <tr> <td>BLUE - BU</td> </tr> <tr> <td>Potential free contact Contatti Puliti</td> <td>ORANGE - OR</td> </tr> <tr> <td>Conductor not disconnected Conduttore non sezionati</td> <td>GREEN/YELLOW - GN/YE</td> </tr> <tr> <td>Ground or Earth connection Connessioni di Terra</td> <td></td> <td></td> </tr> </table>	Designation Color in according to UL508A Colour Abbreviations in according to IEC 60757			WIRING	COLOR	CROSS SECTION	Power circuit Circuito di Potenza	BLACK - BK	as circuit diagram indication	Control line at 230-24Vac Linea di Controllo a 230-24Vac	RED - RD	Control line at 24Vdc Linea di Controllo a 24Vdc	DARK BLUE - DBU	Analog signal Segnali Analogici	WHITE - WH	VIOLET - VT	BLUE - BU	Potential free contact Contatti Puliti	ORANGE - OR	Conductor not disconnected Conduttore non sezionati	GREEN/YELLOW - GN/YE	Ground or Earth connection Connessioni di Terra			<table border="1"> <tr> <th>NFPA</th> <th>IEC</th> <th>DESCRIZIONE</th> </tr> <tr> <td> XM</td> <td> TM</td> <td>SUPPLY TRANSFORMER TRANSFORMATEUR DE PUISSANCE</td> </tr> <tr> <td> DS</td> <td> OS</td> <td>GENERAL SWITCH DÉBRANCHEUR PRINCIPAL</td> </tr> </table>	NFPA	IEC	DESCRIZIONE	XM	TM	SUPPLY TRANSFORMER TRANSFORMATEUR DE PUISSANCE	DS	OS	GENERAL SWITCH DÉBRANCHEUR PRINCIPAL	<table border="1"> <tr> <th>NFPA</th> <th>IEC</th> <th>DESCRIZIONE</th> </tr> <tr> <td> MA</td> <td> MA</td> <td>MOTOR MOTEUR</td> </tr> <tr> <td> FU</td> <td> FU</td> <td>FUSES FUSIBLES</td> </tr> <tr> <td> KA</td> <td> KA</td> <td>NC RELAY CF RELAIS</td> </tr> <tr> <td> KA</td> <td> KA</td> <td>NO RELAY OC RELAIS</td> </tr> <tr> <td> XF</td> <td> XF</td> <td>TRANSFORMER TRANSFORMATEUR</td> </tr> <tr> <td> SP</td> <td> SP</td> <td>HIGH PRESSURE SWITCH PRESSOSTAT HAUTE PRESSION</td> </tr> <tr> <td> SP</td> <td> SP</td> <td>LOW PRESSURE SWITCH PRESSOSTAT BASSE PRESSION</td> </tr> <tr> <td> SL</td> <td> SL</td> <td>CONDENSATE LEVEL SENSOR CAPTEUR DE NIVEAU DE CONDENSAT</td> </tr> <tr> <td> YV</td> <td> YV</td> <td>SOLENOID VALVE ELECTROVANNE</td> </tr> <tr> <td> KA</td> <td> KA</td> <td>RELAY COIL RELAIS DE BOBINE</td> </tr> <tr> <td> KM</td> <td> KM</td> <td>CONTACTOR COIL CONTACTEUR DE BOBINE</td> </tr> <tr> <td> BT</td> <td> BT</td> <td>TEMPERATURE SENSOR CAPTEUR DE TEMPERATURE</td> </tr> <tr> <td> X</td> <td> X</td> <td>THERMINAL BLOCK PINCE</td> </tr> <tr> <td> EH</td> <td> EH</td> <td>CARTER HEATER RÉSISTANCE AU CARTER</td> </tr> <tr> <td> PJ</td> <td> PJ</td> <td>SOCKET PRISE</td> </tr> </table>	NFPA	IEC	DESCRIZIONE	MA	MA	MOTOR MOTEUR	FU	FU	FUSES FUSIBLES	KA	KA	NC RELAY CF RELAIS	KA	KA	NO RELAY OC RELAIS	XF	XF	TRANSFORMER TRANSFORMATEUR	SP	SP	HIGH PRESSURE SWITCH PRESSOSTAT HAUTE PRESSION	SP	SP	LOW PRESSURE SWITCH PRESSOSTAT BASSE PRESSION	SL	SL	CONDENSATE LEVEL SENSOR CAPTEUR DE NIVEAU DE CONDENSAT	YV	YV	SOLENOID VALVE ELECTROVANNE	KA	KA	RELAY COIL RELAIS DE BOBINE	KM	KM	CONTACTOR COIL CONTACTEUR DE BOBINE	BT	BT	TEMPERATURE SENSOR CAPTEUR DE TEMPERATURE	X	X	THERMINAL BLOCK PINCE	EH	EH	CARTER HEATER RÉSISTANCE AU CARTER	PJ	PJ	SOCKET PRISE
		NFPA	IEC	DESCRIZIONE																																																																																																																																																											
DS	OS	GENERAL SWITCH DÉBRANCHEUR PRINCIPAL																																																																																																																																																													
CB	OM	AUTOMATIC THERMAL SWITCH INTERRUPTEUR THERMIQUE AUTOMATIQUE																																																																																																																																																													
M	KM	COMPRESSOR CONTACT CONTACT COMPRESSEUR																																																																																																																																																													
NFPA	IEC	DESCRIZIONE																																																																																																																																																													
OM	OM	AUTOMATIC SWITCH SWITCH AUTOMATIQUE																																																																																																																																																													
FV	FV	PHASE MONITORING RELAY RELAIS DE SURVEILLANCE DE PHASE																																																																																																																																																													
FV	FV	PHASE MONITORING RELAY RELAIS DE SURVEILLANCE DE PHASE																																																																																																																																																													
Tightening Torque - Serrage du couple																																																																																																																																																															
	Nm	In*Lb																																																																																																																																																													
QS1	6	53,1																																																																																																																																																													
QM1	1,7	15,0																																																																																																																																																													
QM1(aux)	1	8,9																																																																																																																																																													
TM1	0,6	5,3																																																																																																																																																													
KM1	3,2	28,9																																																																																																																																																													
KM1(aux)	1,2	10,6																																																																																																																																																													
KM3	1,2	10,6																																																																																																																																																													
KM3(aux)	1,2	10,6																																																																																																																																																													
E0	6	53,1																																																																																																																																																													
fu(10,3X38)	2,3	20,4																																																																																																																																																													
fu(5X20)	0,5	4,4																																																																																																																																																													
FV6	0,8	7,1																																																																																																																																																													
A1,A2,A3(in)	0,2	1,8																																																																																																																																																													
A1,A2,A3(out)	0,6	5,3																																																																																																																																																													
Designation Color in according to UL508A Colour Abbreviations in according to IEC 60757																																																																																																																																																															
WIRING	COLOR	CROSS SECTION																																																																																																																																																													
Power circuit Circuito di Potenza	BLACK - BK	as circuit diagram indication																																																																																																																																																													
Control line at 230-24Vac Linea di Controllo a 230-24Vac	RED - RD																																																																																																																																																														
Control line at 24Vdc Linea di Controllo a 24Vdc	DARK BLUE - DBU																																																																																																																																																														
Analog signal Segnali Analogici	WHITE - WH																																																																																																																																																														
	VIOLET - VT																																																																																																																																																														
	BLUE - BU																																																																																																																																																														
Potential free contact Contatti Puliti	ORANGE - OR																																																																																																																																																														
Conductor not disconnected Conduttore non sezionati	GREEN/YELLOW - GN/YE																																																																																																																																																														
Ground or Earth connection Connessioni di Terra																																																																																																																																																															
NFPA	IEC	DESCRIZIONE																																																																																																																																																													
XM	TM	SUPPLY TRANSFORMER TRANSFORMATEUR DE PUISSANCE																																																																																																																																																													
DS	OS	GENERAL SWITCH DÉBRANCHEUR PRINCIPAL																																																																																																																																																													
NFPA	IEC	DESCRIZIONE																																																																																																																																																													
MA	MA	MOTOR MOTEUR																																																																																																																																																													
FU	FU	FUSES FUSIBLES																																																																																																																																																													
KA	KA	NC RELAY CF RELAIS																																																																																																																																																													
KA	KA	NO RELAY OC RELAIS																																																																																																																																																													
XF	XF	TRANSFORMER TRANSFORMATEUR																																																																																																																																																													
SP	SP	HIGH PRESSURE SWITCH PRESSOSTAT HAUTE PRESSION																																																																																																																																																													
SP	SP	LOW PRESSURE SWITCH PRESSOSTAT BASSE PRESSION																																																																																																																																																													
SL	SL	CONDENSATE LEVEL SENSOR CAPTEUR DE NIVEAU DE CONDENSAT																																																																																																																																																													
YV	YV	SOLENOID VALVE ELECTROVANNE																																																																																																																																																													
KA	KA	RELAY COIL RELAIS DE BOBINE																																																																																																																																																													
KM	KM	CONTACTOR COIL CONTACTEUR DE BOBINE																																																																																																																																																													
BT	BT	TEMPERATURE SENSOR CAPTEUR DE TEMPERATURE																																																																																																																																																													
X	X	THERMINAL BLOCK PINCE																																																																																																																																																													
EH	EH	CARTER HEATER RÉSISTANCE AU CARTER																																																																																																																																																													
PJ	PJ	SOCKET PRISE																																																																																																																																																													
B																																																																																																																																																															
C																																																																																																																																																															
D																																																																																																																																																															
E																																																																																																																																																															
F																																																																																																																																																															

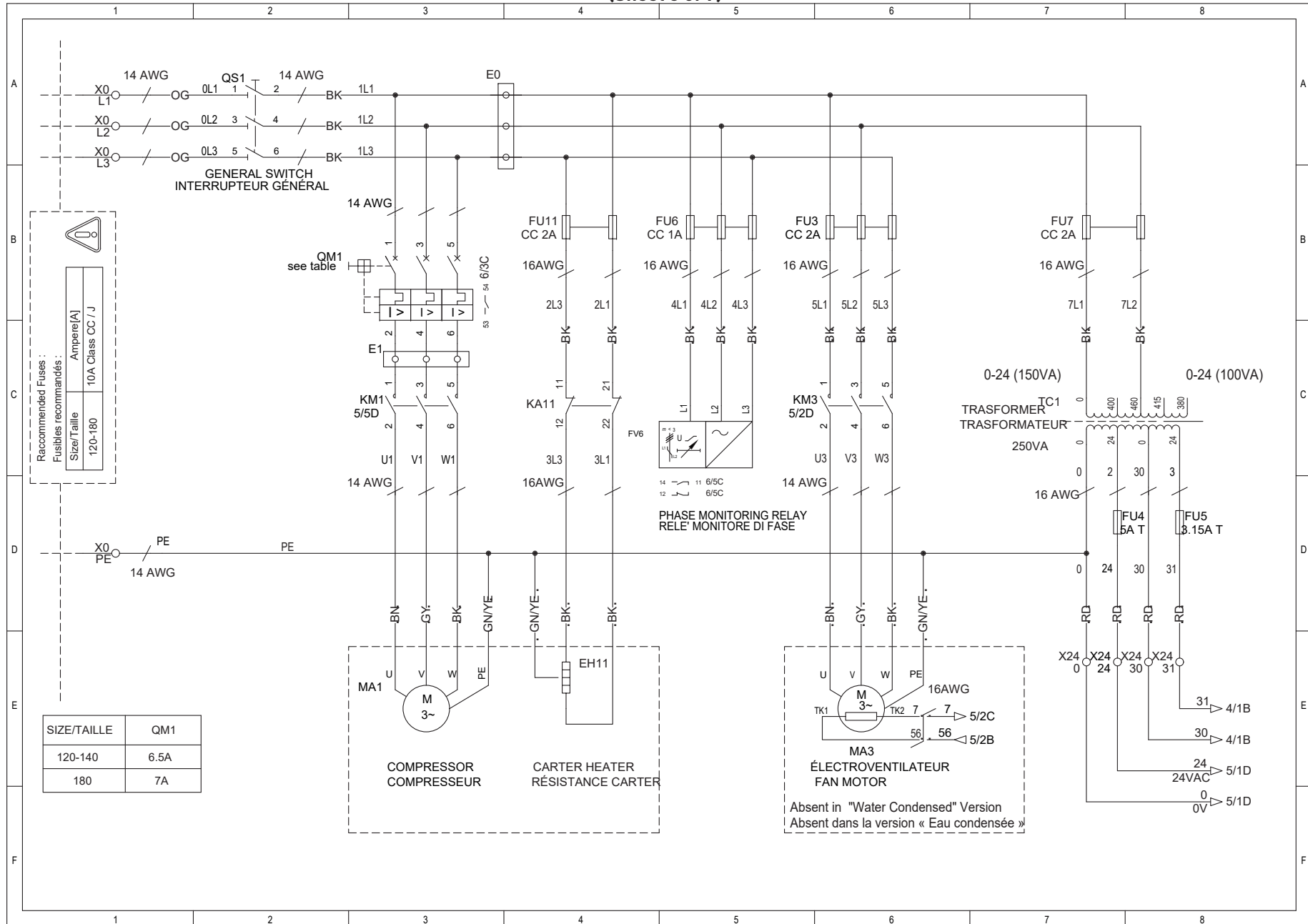

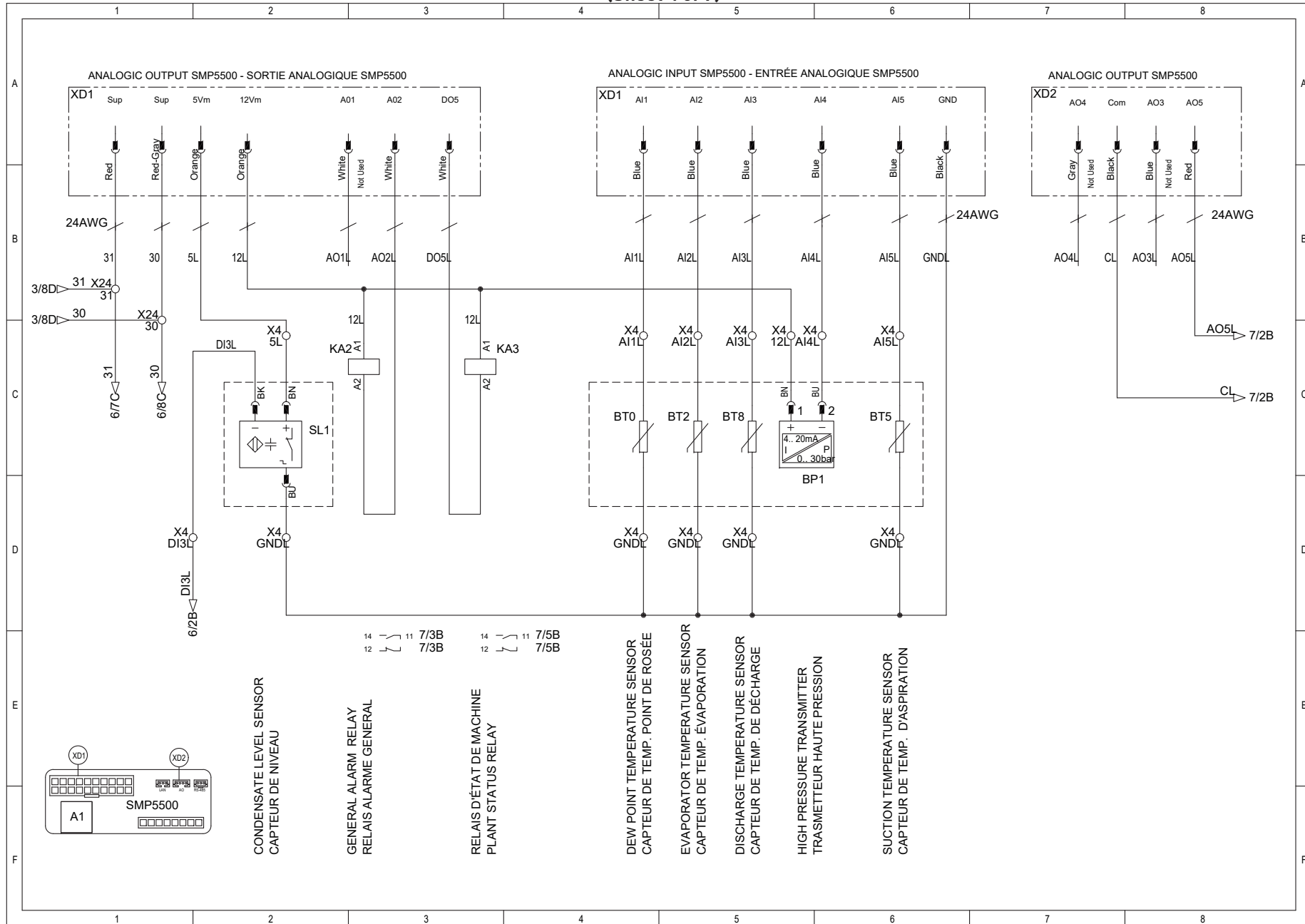

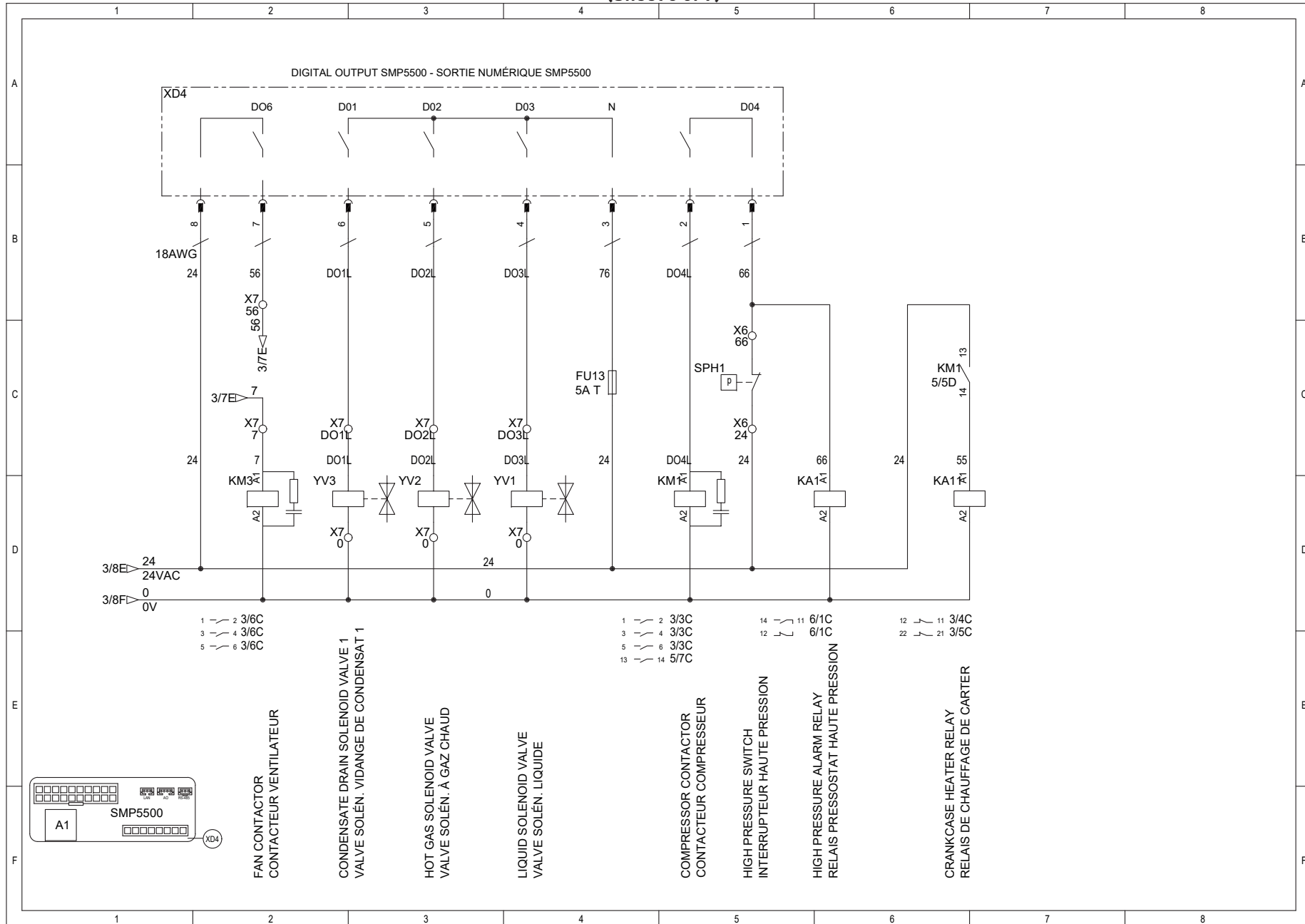

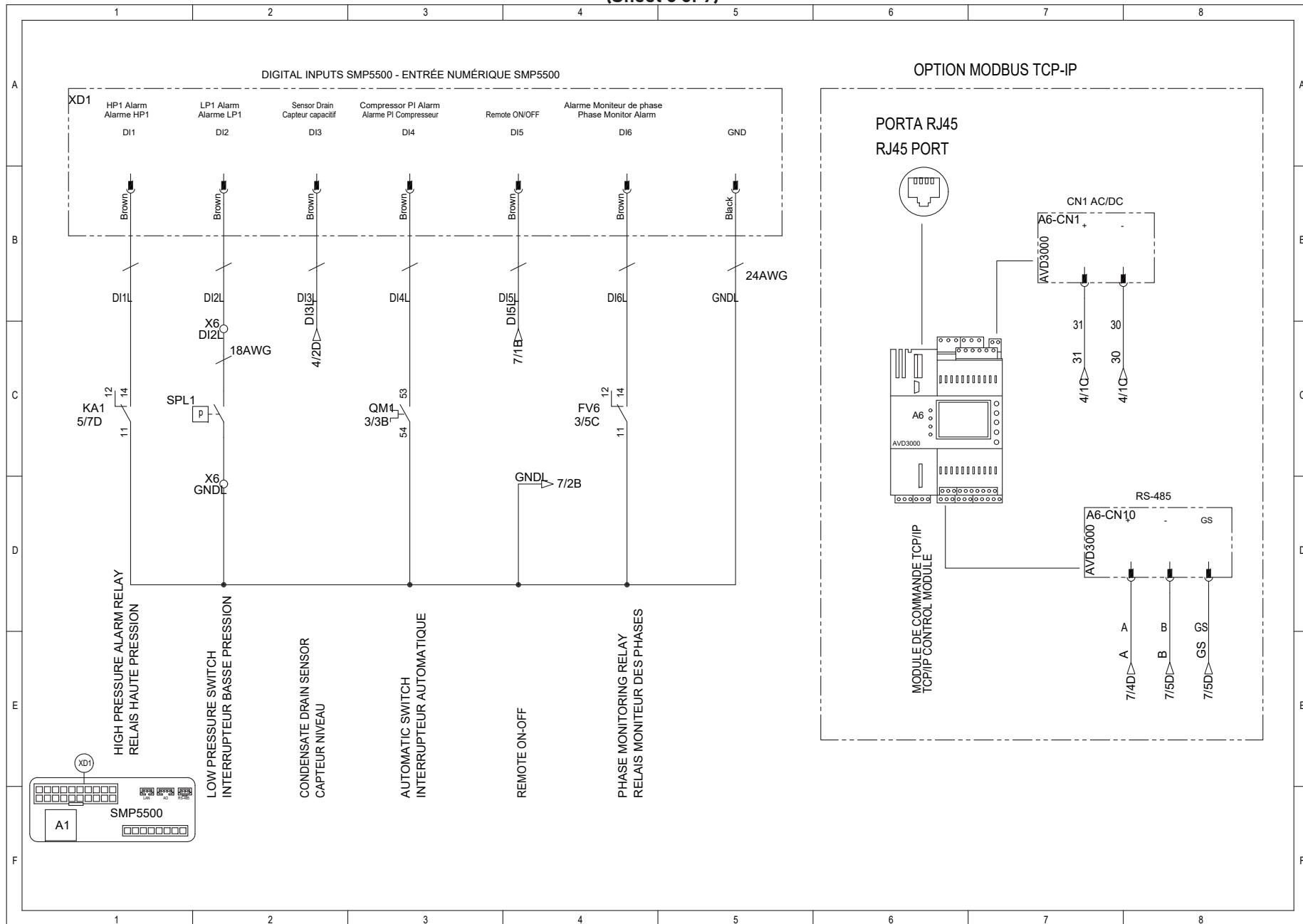

CUSTOMER TERMINAL BLOCKS - TERMINAUX DE CONNEXION CLIENT

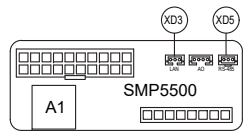
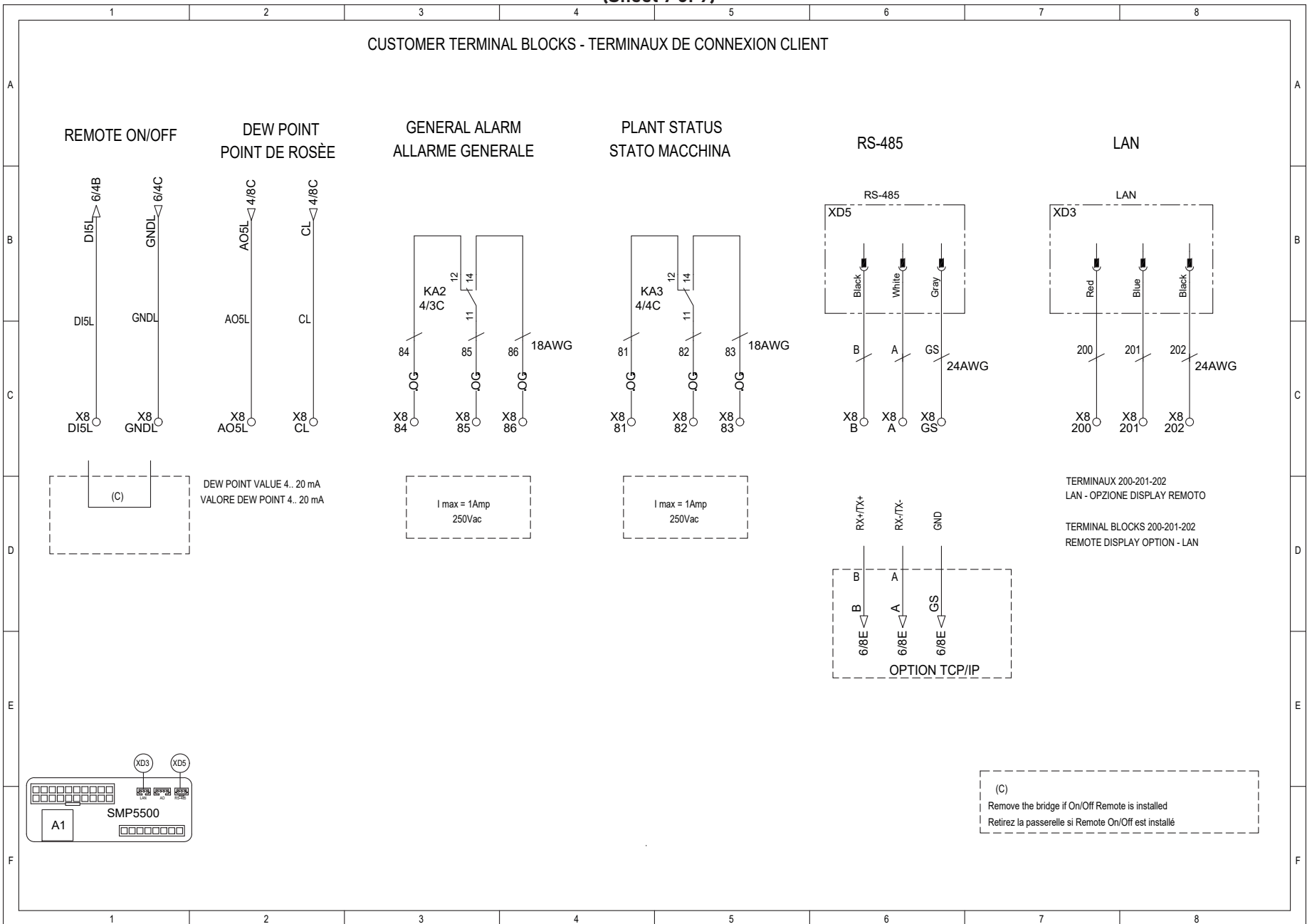

	1	2	3	4	5	6	7	8
A	Terminal Block	X6	X7	X4	X8		X0	
B	Terminal	66	56	A11L	A05L	81	0L1	
C	level down	24	0	GNDL	CL	82	0L2	
D	link down					83	0L3	
E	level up	66		A11L	200	84		
F	link up			A12L	201	85		
	wire up	66	56	A13L	202	86		
	wire down	24	7	A15L				
		SPH1	MA3	SL1	BP1	C		
	refrigerant high pressure switch		YV1	BT0		NC		
	refrigerant low pressure switch		YV2	BT2		NO		
	fan motor internal protection		YV3	BT5				
	liquid valve			SL1				
	hot gas valve			BP1				
	condensate drain valve 1							
	ADS inlet temperature							
	evaporator temperature							
	refrigerant discharge temperature							
	refrigerant suction temperature							
	condensate level sensor							
	condensate level sensor							
	high pressure transmitter							
	4.. 20mA PDP value remote ON/OFF							
	Modbus RTU su RS485 LAN remote display							
	plant status relay							
	general alarm relay							
	power line							

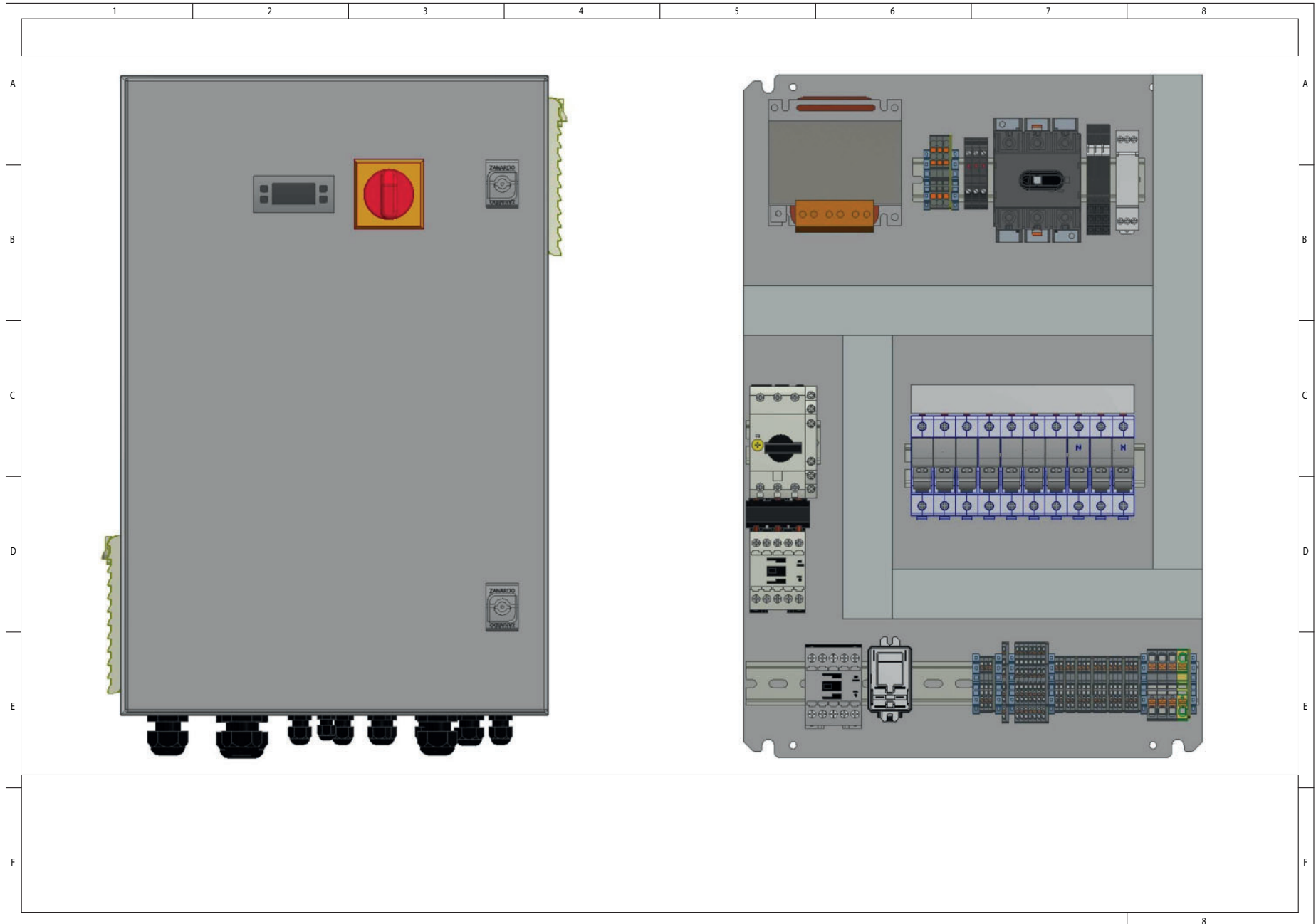

DRYER SIZE	COMPRESSOR					FAN MOTOR					CRANKCASE HEATER				AUXILIARY		
	TAG	FLA [A]	Pn		LRA [A]	TAG	FLA [A]	FLA [A]		LRA [A]	TAG	FLA [A]		FLA [A]	FLA [A]		FLA [A]
			kW	Hp				kW	Hp			kW	Hp		kW	Hp	
220 (700)	MA1	8,3	4,5	6	60	MA3	1,02	0,7100	1/2	10	EH11	0,070	--	0,15	0,3	--	0,9
260 (800)		9,6	5,3	7 1/2	70												
300 (1000)			6,9		80												

GENERAL DATA / DONNÉES GENERALES			
ELECTRICAL PANEL	398H316908		
DRYER SIZE	220	260	300
Pn [kW]	5,2	6,3	7,6
FLA [A]	9,3	10,6	
MCA [A]	11,5	13	
MOP [A]	15	20	

ITEM	398H316908
Supply Voltage Tension d'alimentation	460V - 3Ph - 60Hz
Control Voltage Tension auxiliaire	24Vac / 24Vdc
Enclosed type	TYPE 1
Residual current switch and fuses Disjoncteur et fusibles à courant résiduel	RCCB Id 0.3A class A and Fuses CC / J
SCCR 220-300 SCCR (700-1000)	50 kA
Grounding Mise à la terre	Solidly grounded
Additional Opzioni	/

SH	DESCRIPTION	DESCRIPTION
1	Electrical data	Données techniques
2	Electrical data	Données techniques
3	Power circuit	Circuit d'alimentation
4	Auxiliary circuits	Circuit auxiliaire
5	Auxiliary circuits	Circuit auxiliaire
6	Auxiliary circuits	Circuit auxiliaire
7	Auxiliary circuits	Circuit auxiliaire
8	Auxiliary circuits	Circuit auxiliaire
9	Customer interface	Interface client
10	Terminal blocks	Blocs terminaux
11	Electrical panel layout	Planimétrie du panneau électrique
12	Components list	Liste de composants
13	Components list	Liste de composants
14	Fuses list	Liste des fusibles
15	On machine	Sur machine
16	Cables list	Liste de cables
17	Cabinet	Charpenterie

ELECTRICAL SUPPLY LINE - LINEA ALIMENTAZIONE 460/3Ph/60Hz
CABLES SIZE - DIMENSIONI CAVI SEE TABLE (MCA) - VEDERE TABELLA (MCA)

	1	2	3	4	5	6	7	8																																																																																																																																																																																											
A	<table border="1"> <tr> <th>NFPA</th> <th>IEC</th> <th>DESCRIZIONE</th> </tr> <tr> <td> DS</td> <td> QS</td> <td>GENERAL SWITCH DÉBRANCHEUR PRINCIPAL</td> </tr> <tr> <td> CB</td> <td> QM</td> <td>AUTOMATIC THERMAL SWITCH INTERRUPTEUR THERMIQUE AUTOMATIQUE</td> </tr> <tr> <td> M</td> <td> KM</td> <td>COMPRESSOR CONTACT CONTACT COMPRESSEUR</td> </tr> <tr> <td> MOT</td> <td> MA</td> <td>MOTOR MOTEUR</td> </tr> <tr> <td> FU</td> <td> FU</td> <td>FUSES FUSIBLES</td> </tr> <tr> <td> CR</td> <td> KA</td> <td>NC RELAY CF RELAIS</td> </tr> <tr> <td> CR</td> <td> KA</td> <td>NO RELAY OC RELAIS</td> </tr> <tr> <td rowspan="2">B</td> <td rowspan="2"> <table border="1"> <tr> <th>NFPA</th> <th>IEC</th> <th>DESCRIZIONE</th> </tr> <tr> <td> FV</td> <td> FV</td> <td>PHASE MONITORING RELAY RELAIS DE SURVEILLANCE DE PHASE</td> </tr> <tr> <td> FV</td> <td> FV</td> <td>PHASE MONITORING RELAY RELAIS DE SURVEILLANCE DE PHASE</td> </tr> <tr> <td> XM</td> <td> TM</td> <td>SUPPLY TRANSFORMER TRASFORMATEUR DE PUISSANCE</td> </tr> <tr> <td> DS</td> <td> QS</td> <td>GENERAL SWITCH DÉBRANCHEUR PRINCIPAL</td> </tr> </table> </td> <td rowspan="2"> <table border="1"> <tr> <th colspan="3">Tightening Torque - Serrage du couple</th> </tr> <tr> <th></th> <th>Nm</th> <th>ln*Lb</th> </tr> <tr> <td>QS1</td> <td>6</td> <td>53,1</td> </tr> <tr> <td>QM1</td> <td>1,7</td> <td>15,0</td> </tr> <tr> <td>QM1(aux)</td> <td>1</td> <td>8,9</td> </tr> <tr> <td>TM1</td> <td>0,6</td> <td>5,3</td> </tr> <tr> <td>KM1</td> <td>3,2</td> <td>28,9</td> </tr> <tr> <td>KM1(aux)</td> <td>1,2</td> <td>10,6</td> </tr> <tr> <td>KM3</td> <td>1,2</td> <td>10,6</td> </tr> <tr> <td>KM3(aux)</td> <td>1,2</td> <td>10,6</td> </tr> <tr> <td>E0</td> <td>6</td> <td>53,1</td> </tr> <tr> <td>fu(10,3X38)</td> <td>2,3</td> <td>20,4</td> </tr> <tr> <td>fu(5X20)</td> <td>0,5</td> <td>4,4</td> </tr> <tr> <td>FV6</td> <td>0,8</td> <td>7,1</td> </tr> <tr> <td>A1,A2,A3(in)</td> <td>0,2</td> <td>1,8</td> </tr> <tr> <td>A1,A2,A3(out)</td> <td>0,6</td> <td>5,3</td> </tr> </table> </td> <td rowspan="2"> <table border="1"> <tr> <th colspan="3">Designation Color in according to UL508A Colour Abbreviations in according to IEC 60757</th> </tr> <tr> <th>WIRING</th> <th>COLOR</th> <th>CROSS SECTION</th> </tr> <tr> <td>Power circuit Circuito di Potenza</td> <td>BLACK - BK</td> <td rowspan="2"></td> </tr> <tr> <td>Control line at 230-24Vac Linea di Controllo a 230-24Vac</td> <td>RED - RD</td> </tr> <tr> <td>Control line at 24Vdc Linea di Controllo a 24Vdc</td> <td>DARK BLUE - DBU</td> <td rowspan="3">as circuit diagram indication</td> </tr> <tr> <td rowspan="2">Analog signal Segnali Analogici</td> <td>WHITE - WH</td> </tr> <tr> <td>VIOLET - VT</td> </tr> <tr> <td>Potential free contact Contatti Puri</td> <td>BLUE - BU</td> </tr> <tr> <td>Conductor not disconnected Conduttore non sezionati</td> <td>ORANGE - OR</td> <td rowspan="2"></td> </tr> <tr> <td>Ground or Earth connection Connessioni di Terra</td> <td>GREEN/YELLOW - GN/YE</td> </tr> </table> </td> <td rowspan="2"> <table border="1"> <tr> <th>NFPA</th> <th>IEC</th> <th>DESCRIZIONE</th> </tr> <tr> <td> DS</td> <td> QS</td> <td>GENERAL SWITCH DÉBRANCHEUR PRINCIPAL</td> </tr> <tr> <td> CB</td> <td> QM</td> <td>AUTOMATIC THERMAL SWITCH INTERRUPTEUR THERMIQUE AUTOMATIQUE</td> </tr> <tr> <td> M</td> <td> KM</td> <td>COMPRESSOR CONTACT CONTACT COMPRESSEUR</td> </tr> <tr> <td> MOT</td> <td> MA</td> <td>MOTOR MOTEUR</td> </tr> <tr> <td> FU</td> <td> FU</td> <td>FUSES FUSIBLES</td> </tr> <tr> <td> CR</td> <td> KA</td> <td>NC RELAY CF RELAIS</td> </tr> <tr> <td> CR</td> <td> KA</td> <td>NO RELAY OC RELAIS</td> </tr> <tr> <td rowspan="2">C</td> <td rowspan="2"> <table border="1"> <tr> <th>NFPA</th> <th>IEC</th> <th>DESCRIZIONE</th> </tr> <tr> <td> XF</td> <td> XF</td> <td>TRANSFORMER TRANSFORMATEUR</td> </tr> <tr> <td> PS</td> <td> SP</td> <td>HIGH PRESSURE SWITCH PRESSOSTAT HAUTE PRESSION</td> </tr> <tr> <td> PS</td> <td> SP</td> <td>LOW PRESSURE SWITCH PRESSOSTAT BASSE PRESSION</td> </tr> <tr> <td> LS</td> <td> SL</td> <td>CONDENSATE LEVEL SENSOR CAPTEUR DE NIVEAU DE CONDENSAT</td> </tr> <tr> <td rowspan="2">D</td> <td rowspan="2"> <table border="1"> <tr> <th>NFPA</th> <th>IEC</th> <th>DESCRIZIONE</th> </tr> <tr> <td> SOL</td> <td> YV</td> <td>SOLENOID VALVE ELECTROVANNE</td> </tr> <tr> <td> CR</td> <td> KA</td> <td>RELAY COIL RELAIS DE BOBINE</td> </tr> <tr> <td> M</td> <td> KM</td> <td>CONTACTOR COIL CONTACTEUR DE BOBINE</td> </tr> <tr> <td rowspan="2">E</td> <td rowspan="2"> <table border="1"> <tr> <th>NFPA</th> <th>IEC</th> <th>DESCRIZIONE</th> </tr> <tr> <td> RA</td> <td> BT</td> <td>TEMPERATURE SENSOR CAPTEUR DE TEMPERATURE</td> </tr> <tr> <td> TB</td> <td> X</td> <td>THERMINAL BLOCK PINCE</td> </tr> <tr> <td> RE</td> <td> EH</td> <td>CARTER HEATER RÉSISTANCE AU CARTER</td> </tr> <tr> <td rowspan="2">F</td> <td rowspan="2"> <table border="1"> <tr> <th>NFPA</th> <th>IEC</th> <th>DESCRIZIONE</th> </tr> <tr> <td> PJ</td> <td> PJ</td> <td>SOCKET PRISE</td> </tr> </table> </td> <td></td> </tr> </table></td></tr></table></td></tr></table></td></tr></table></td></tr></table>	NFPA	IEC	DESCRIZIONE	DS	QS	GENERAL SWITCH DÉBRANCHEUR PRINCIPAL	CB	QM	AUTOMATIC THERMAL SWITCH INTERRUPTEUR THERMIQUE AUTOMATIQUE	M	KM	COMPRESSOR CONTACT CONTACT COMPRESSEUR	MOT	MA	MOTOR MOTEUR	FU	FU	FUSES FUSIBLES	CR	KA	NC RELAY CF RELAIS	CR	KA	NO RELAY OC RELAIS	B	<table border="1"> <tr> <th>NFPA</th> <th>IEC</th> <th>DESCRIZIONE</th> </tr> <tr> <td> FV</td> <td> FV</td> <td>PHASE MONITORING RELAY RELAIS DE SURVEILLANCE DE PHASE</td> </tr> <tr> <td> FV</td> <td> FV</td> <td>PHASE MONITORING RELAY RELAIS DE SURVEILLANCE DE PHASE</td> </tr> <tr> <td> XM</td> <td> TM</td> <td>SUPPLY TRANSFORMER TRASFORMATEUR DE PUISSANCE</td> </tr> <tr> <td> DS</td> <td> QS</td> <td>GENERAL SWITCH DÉBRANCHEUR PRINCIPAL</td> </tr> </table>	NFPA	IEC	DESCRIZIONE	FV	FV	PHASE MONITORING RELAY RELAIS DE SURVEILLANCE DE PHASE	FV	FV	PHASE MONITORING RELAY RELAIS DE SURVEILLANCE DE PHASE	XM	TM	SUPPLY TRANSFORMER TRASFORMATEUR DE PUISSANCE	DS	QS	GENERAL SWITCH DÉBRANCHEUR PRINCIPAL	<table border="1"> <tr> <th colspan="3">Tightening Torque - Serrage du couple</th> </tr> <tr> <th></th> <th>Nm</th> <th>ln*Lb</th> </tr> <tr> <td>QS1</td> <td>6</td> <td>53,1</td> </tr> <tr> <td>QM1</td> <td>1,7</td> <td>15,0</td> </tr> <tr> <td>QM1(aux)</td> <td>1</td> <td>8,9</td> </tr> <tr> <td>TM1</td> <td>0,6</td> <td>5,3</td> </tr> <tr> <td>KM1</td> <td>3,2</td> <td>28,9</td> </tr> <tr> <td>KM1(aux)</td> <td>1,2</td> <td>10,6</td> </tr> <tr> <td>KM3</td> <td>1,2</td> <td>10,6</td> </tr> <tr> <td>KM3(aux)</td> <td>1,2</td> <td>10,6</td> </tr> <tr> <td>E0</td> <td>6</td> <td>53,1</td> </tr> <tr> <td>fu(10,3X38)</td> <td>2,3</td> <td>20,4</td> </tr> <tr> <td>fu(5X20)</td> <td>0,5</td> <td>4,4</td> </tr> <tr> <td>FV6</td> <td>0,8</td> <td>7,1</td> </tr> <tr> <td>A1,A2,A3(in)</td> <td>0,2</td> <td>1,8</td> </tr> <tr> <td>A1,A2,A3(out)</td> <td>0,6</td> <td>5,3</td> </tr> </table>	Tightening Torque - Serrage du couple				Nm	ln*Lb	QS1	6	53,1	QM1	1,7	15,0	QM1(aux)	1	8,9	TM1	0,6	5,3	KM1	3,2	28,9	KM1(aux)	1,2	10,6	KM3	1,2	10,6	KM3(aux)	1,2	10,6	E0	6	53,1	fu(10,3X38)	2,3	20,4	fu(5X20)	0,5	4,4	FV6	0,8	7,1	A1,A2,A3(in)	0,2	1,8	A1,A2,A3(out)	0,6	5,3	<table border="1"> <tr> <th colspan="3">Designation Color in according to UL508A Colour Abbreviations in according to IEC 60757</th> </tr> <tr> <th>WIRING</th> <th>COLOR</th> <th>CROSS SECTION</th> </tr> <tr> <td>Power circuit Circuito di Potenza</td> <td>BLACK - BK</td> <td rowspan="2"></td> </tr> <tr> <td>Control line at 230-24Vac Linea di Controllo a 230-24Vac</td> <td>RED - RD</td> </tr> <tr> <td>Control line at 24Vdc Linea di Controllo a 24Vdc</td> <td>DARK BLUE - DBU</td> <td rowspan="3">as circuit diagram indication</td> </tr> <tr> <td rowspan="2">Analog signal Segnali Analogici</td> <td>WHITE - WH</td> </tr> <tr> <td>VIOLET - VT</td> </tr> <tr> <td>Potential free contact Contatti Puri</td> <td>BLUE - BU</td> </tr> <tr> <td>Conductor not disconnected Conduttore non sezionati</td> <td>ORANGE - OR</td> <td rowspan="2"></td> </tr> <tr> <td>Ground or Earth connection Connessioni di Terra</td> <td>GREEN/YELLOW - GN/YE</td> </tr> </table>	Designation Color in according to UL508A Colour Abbreviations in according to IEC 60757			WIRING	COLOR	CROSS SECTION	Power circuit Circuito di Potenza	BLACK - BK		Control line at 230-24Vac Linea di Controllo a 230-24Vac	RED - RD	Control line at 24Vdc Linea di Controllo a 24Vdc	DARK BLUE - DBU	as circuit diagram indication	Analog signal Segnali Analogici	WHITE - WH	VIOLET - VT	Potential free contact Contatti Puri	BLUE - BU	Conductor not disconnected Conduttore non sezionati	ORANGE - OR		Ground or Earth connection Connessioni di Terra	GREEN/YELLOW - GN/YE	<table border="1"> <tr> <th>NFPA</th> <th>IEC</th> <th>DESCRIZIONE</th> </tr> <tr> <td> DS</td> <td> QS</td> <td>GENERAL SWITCH DÉBRANCHEUR PRINCIPAL</td> </tr> <tr> <td> CB</td> <td> QM</td> <td>AUTOMATIC THERMAL SWITCH INTERRUPTEUR THERMIQUE AUTOMATIQUE</td> </tr> <tr> <td> M</td> <td> KM</td> <td>COMPRESSOR CONTACT CONTACT COMPRESSEUR</td> </tr> <tr> <td> MOT</td> <td> MA</td> <td>MOTOR MOTEUR</td> </tr> <tr> <td> FU</td> <td> FU</td> <td>FUSES FUSIBLES</td> </tr> <tr> <td> CR</td> <td> KA</td> <td>NC RELAY CF RELAIS</td> </tr> <tr> <td> CR</td> <td> KA</td> <td>NO RELAY OC RELAIS</td> </tr> <tr> <td rowspan="2">C</td> <td rowspan="2"> <table border="1"> <tr> <th>NFPA</th> <th>IEC</th> <th>DESCRIZIONE</th> </tr> <tr> <td> XF</td> <td> XF</td> <td>TRANSFORMER TRANSFORMATEUR</td> </tr> <tr> <td> PS</td> <td> SP</td> <td>HIGH PRESSURE SWITCH PRESSOSTAT HAUTE PRESSION</td> </tr> <tr> <td> PS</td> <td> SP</td> <td>LOW PRESSURE SWITCH PRESSOSTAT BASSE PRESSION</td> </tr> <tr> <td> LS</td> <td> SL</td> <td>CONDENSATE LEVEL SENSOR CAPTEUR DE NIVEAU DE CONDENSAT</td> </tr> <tr> <td rowspan="2">D</td> <td rowspan="2"> <table border="1"> <tr> <th>NFPA</th> <th>IEC</th> <th>DESCRIZIONE</th> </tr> <tr> <td> SOL</td> <td> YV</td> <td>SOLENOID VALVE ELECTROVANNE</td> </tr> <tr> <td> CR</td> <td> KA</td> <td>RELAY COIL RELAIS DE BOBINE</td> </tr> <tr> <td> M</td> <td> KM</td> <td>CONTACTOR COIL CONTACTEUR DE BOBINE</td> </tr> <tr> <td rowspan="2">E</td> <td rowspan="2"> <table border="1"> <tr> <th>NFPA</th> <th>IEC</th> <th>DESCRIZIONE</th> </tr> <tr> <td> RA</td> <td> BT</td> <td>TEMPERATURE SENSOR CAPTEUR DE TEMPERATURE</td> </tr> <tr> <td> TB</td> <td> X</td> <td>THERMINAL BLOCK PINCE</td> </tr> <tr> <td> RE</td> <td> EH</td> <td>CARTER HEATER RÉSISTANCE AU CARTER</td> </tr> <tr> <td rowspan="2">F</td> <td rowspan="2"> <table border="1"> <tr> <th>NFPA</th> <th>IEC</th> <th>DESCRIZIONE</th> </tr> <tr> <td> PJ</td> <td> PJ</td> <td>SOCKET PRISE</td> </tr> </table> </td> <td></td> </tr> </table></td></tr></table></td></tr></table></td></tr></table>	NFPA	IEC	DESCRIZIONE	DS	QS	GENERAL SWITCH DÉBRANCHEUR PRINCIPAL	CB	QM	AUTOMATIC THERMAL SWITCH INTERRUPTEUR THERMIQUE AUTOMATIQUE	M	KM	COMPRESSOR CONTACT CONTACT COMPRESSEUR	MOT	MA	MOTOR MOTEUR	FU	FU	FUSES FUSIBLES	CR	KA	NC RELAY CF RELAIS	CR	KA	NO RELAY OC RELAIS	C	<table border="1"> <tr> <th>NFPA</th> <th>IEC</th> <th>DESCRIZIONE</th> </tr> <tr> <td> XF</td> <td> XF</td> <td>TRANSFORMER TRANSFORMATEUR</td> </tr> <tr> <td> PS</td> <td> SP</td> <td>HIGH PRESSURE SWITCH PRESSOSTAT HAUTE PRESSION</td> </tr> <tr> <td> PS</td> <td> SP</td> <td>LOW PRESSURE SWITCH PRESSOSTAT BASSE PRESSION</td> </tr> <tr> <td> LS</td> <td> SL</td> <td>CONDENSATE LEVEL SENSOR CAPTEUR DE NIVEAU DE CONDENSAT</td> </tr> <tr> <td rowspan="2">D</td> <td rowspan="2"> <table border="1"> <tr> <th>NFPA</th> <th>IEC</th> <th>DESCRIZIONE</th> </tr> <tr> <td> SOL</td> <td> YV</td> <td>SOLENOID VALVE ELECTROVANNE</td> </tr> <tr> <td> CR</td> <td> KA</td> <td>RELAY COIL RELAIS DE BOBINE</td> </tr> <tr> <td> M</td> <td> KM</td> <td>CONTACTOR COIL CONTACTEUR DE BOBINE</td> </tr> <tr> <td rowspan="2">E</td> <td rowspan="2"> <table border="1"> <tr> <th>NFPA</th> <th>IEC</th> <th>DESCRIZIONE</th> </tr> <tr> <td> RA</td> <td> BT</td> <td>TEMPERATURE SENSOR CAPTEUR DE TEMPERATURE</td> </tr> <tr> <td> TB</td> <td> X</td> <td>THERMINAL BLOCK PINCE</td> </tr> <tr> <td> RE</td> <td> EH</td> <td>CARTER HEATER RÉSISTANCE AU CARTER</td> </tr> <tr> <td rowspan="2">F</td> <td rowspan="2"> <table border="1"> <tr> <th>NFPA</th> <th>IEC</th> <th>DESCRIZIONE</th> </tr> <tr> <td> PJ</td> <td> PJ</td> <td>SOCKET PRISE</td> </tr> </table> </td> <td></td> </tr> </table></td></tr></table></td></tr></table>	NFPA	IEC	DESCRIZIONE	XF	XF	TRANSFORMER TRANSFORMATEUR	PS	SP	HIGH PRESSURE SWITCH PRESSOSTAT HAUTE PRESSION	PS	SP	LOW PRESSURE SWITCH PRESSOSTAT BASSE PRESSION	LS	SL	CONDENSATE LEVEL SENSOR CAPTEUR DE NIVEAU DE CONDENSAT	D	<table border="1"> <tr> <th>NFPA</th> <th>IEC</th> <th>DESCRIZIONE</th> </tr> <tr> <td> SOL</td> <td> YV</td> <td>SOLENOID VALVE ELECTROVANNE</td> </tr> <tr> <td> CR</td> <td> KA</td> <td>RELAY COIL RELAIS DE BOBINE</td> </tr> <tr> <td> M</td> <td> KM</td> <td>CONTACTOR COIL CONTACTEUR DE BOBINE</td> </tr> <tr> <td rowspan="2">E</td> <td rowspan="2"> <table border="1"> <tr> <th>NFPA</th> <th>IEC</th> <th>DESCRIZIONE</th> </tr> <tr> <td> RA</td> <td> BT</td> <td>TEMPERATURE SENSOR CAPTEUR DE TEMPERATURE</td> </tr> <tr> <td> TB</td> <td> X</td> <td>THERMINAL BLOCK PINCE</td> </tr> <tr> <td> RE</td> <td> EH</td> <td>CARTER HEATER RÉSISTANCE AU CARTER</td> </tr> <tr> <td rowspan="2">F</td> <td rowspan="2"> <table border="1"> <tr> <th>NFPA</th> <th>IEC</th> <th>DESCRIZIONE</th> </tr> <tr> <td> PJ</td> <td> PJ</td> <td>SOCKET PRISE</td> </tr> </table> </td> <td></td> </tr> </table></td></tr></table>	NFPA	IEC	DESCRIZIONE	SOL	YV	SOLENOID VALVE ELECTROVANNE	CR	KA	RELAY COIL RELAIS DE BOBINE	M	KM	CONTACTOR COIL CONTACTEUR DE BOBINE	E	<table border="1"> <tr> <th>NFPA</th> <th>IEC</th> <th>DESCRIZIONE</th> </tr> <tr> <td> RA</td> <td> BT</td> <td>TEMPERATURE SENSOR CAPTEUR DE TEMPERATURE</td> </tr> <tr> <td> TB</td> <td> X</td> <td>THERMINAL BLOCK PINCE</td> </tr> <tr> <td> RE</td> <td> EH</td> <td>CARTER HEATER RÉSISTANCE AU CARTER</td> </tr> <tr> <td rowspan="2">F</td> <td rowspan="2"> <table border="1"> <tr> <th>NFPA</th> <th>IEC</th> <th>DESCRIZIONE</th> </tr> <tr> <td> PJ</td> <td> PJ</td> <td>SOCKET PRISE</td> </tr> </table> </td> <td></td> </tr> </table>	NFPA	IEC	DESCRIZIONE	RA	BT	TEMPERATURE SENSOR CAPTEUR DE TEMPERATURE	TB	X	THERMINAL BLOCK PINCE	RE	EH	CARTER HEATER RÉSISTANCE AU CARTER	F	<table border="1"> <tr> <th>NFPA</th> <th>IEC</th> <th>DESCRIZIONE</th> </tr> <tr> <td> PJ</td> <td> PJ</td> <td>SOCKET PRISE</td> </tr> </table>	NFPA	IEC	DESCRIZIONE	PJ	PJ	SOCKET PRISE	
		NFPA	IEC	DESCRIZIONE																																																																																																																																																																																															
DS	QS	GENERAL SWITCH DÉBRANCHEUR PRINCIPAL																																																																																																																																																																																																	
CB	QM	AUTOMATIC THERMAL SWITCH INTERRUPTEUR THERMIQUE AUTOMATIQUE																																																																																																																																																																																																	
M	KM	COMPRESSOR CONTACT CONTACT COMPRESSEUR																																																																																																																																																																																																	
MOT	MA	MOTOR MOTEUR																																																																																																																																																																																																	
FU	FU	FUSES FUSIBLES																																																																																																																																																																																																	
CR	KA	NC RELAY CF RELAIS																																																																																																																																																																																																	
CR	KA	NO RELAY OC RELAIS																																																																																																																																																																																																	
B	<table border="1"> <tr> <th>NFPA</th> <th>IEC</th> <th>DESCRIZIONE</th> </tr> <tr> <td> FV</td> <td> FV</td> <td>PHASE MONITORING RELAY RELAIS DE SURVEILLANCE DE PHASE</td> </tr> <tr> <td> FV</td> <td> FV</td> <td>PHASE MONITORING RELAY RELAIS DE SURVEILLANCE DE PHASE</td> </tr> <tr> <td> XM</td> <td> TM</td> <td>SUPPLY TRANSFORMER TRASFORMATEUR DE PUISSANCE</td> </tr> <tr> <td> DS</td> <td> QS</td> <td>GENERAL SWITCH DÉBRANCHEUR PRINCIPAL</td> </tr> </table>	NFPA	IEC	DESCRIZIONE	FV	FV	PHASE MONITORING RELAY RELAIS DE SURVEILLANCE DE PHASE	FV	FV	PHASE MONITORING RELAY RELAIS DE SURVEILLANCE DE PHASE	XM	TM	SUPPLY TRANSFORMER TRASFORMATEUR DE PUISSANCE	DS	QS	GENERAL SWITCH DÉBRANCHEUR PRINCIPAL	<table border="1"> <tr> <th colspan="3">Tightening Torque - Serrage du couple</th> </tr> <tr> <th></th> <th>Nm</th> <th>ln*Lb</th> </tr> <tr> <td>QS1</td> <td>6</td> <td>53,1</td> </tr> <tr> <td>QM1</td> <td>1,7</td> <td>15,0</td> </tr> <tr> <td>QM1(aux)</td> <td>1</td> <td>8,9</td> </tr> <tr> <td>TM1</td> <td>0,6</td> <td>5,3</td> </tr> <tr> <td>KM1</td> <td>3,2</td> <td>28,9</td> </tr> <tr> <td>KM1(aux)</td> <td>1,2</td> <td>10,6</td> </tr> <tr> <td>KM3</td> <td>1,2</td> <td>10,6</td> </tr> <tr> <td>KM3(aux)</td> <td>1,2</td> <td>10,6</td> </tr> <tr> <td>E0</td> <td>6</td> <td>53,1</td> </tr> <tr> <td>fu(10,3X38)</td> <td>2,3</td> <td>20,4</td> </tr> <tr> <td>fu(5X20)</td> <td>0,5</td> <td>4,4</td> </tr> <tr> <td>FV6</td> <td>0,8</td> <td>7,1</td> </tr> <tr> <td>A1,A2,A3(in)</td> <td>0,2</td> <td>1,8</td> </tr> <tr> <td>A1,A2,A3(out)</td> <td>0,6</td> <td>5,3</td> </tr> </table>	Tightening Torque - Serrage du couple				Nm	ln*Lb	QS1	6	53,1	QM1	1,7	15,0	QM1(aux)	1	8,9	TM1	0,6	5,3	KM1	3,2	28,9	KM1(aux)	1,2	10,6	KM3	1,2	10,6	KM3(aux)	1,2	10,6	E0	6	53,1	fu(10,3X38)	2,3	20,4	fu(5X20)	0,5	4,4	FV6	0,8	7,1	A1,A2,A3(in)	0,2	1,8	A1,A2,A3(out)	0,6	5,3	<table border="1"> <tr> <th colspan="3">Designation Color in according to UL508A Colour Abbreviations in according to IEC 60757</th> </tr> <tr> <th>WIRING</th> <th>COLOR</th> <th>CROSS SECTION</th> </tr> <tr> <td>Power circuit Circuito di Potenza</td> <td>BLACK - BK</td> <td rowspan="2"></td> </tr> <tr> <td>Control line at 230-24Vac Linea di Controllo a 230-24Vac</td> <td>RED - RD</td> </tr> <tr> <td>Control line at 24Vdc Linea di Controllo a 24Vdc</td> <td>DARK BLUE - DBU</td> <td rowspan="3">as circuit diagram indication</td> </tr> <tr> <td rowspan="2">Analog signal Segnali Analogici</td> <td>WHITE - WH</td> </tr> <tr> <td>VIOLET - VT</td> </tr> <tr> <td>Potential free contact Contatti Puri</td> <td>BLUE - BU</td> </tr> <tr> <td>Conductor not disconnected Conduttore non sezionati</td> <td>ORANGE - OR</td> <td rowspan="2"></td> </tr> <tr> <td>Ground or Earth connection Connessioni di Terra</td> <td>GREEN/YELLOW - GN/YE</td> </tr> </table>	Designation Color in according to UL508A Colour Abbreviations in according to IEC 60757			WIRING	COLOR	CROSS SECTION	Power circuit Circuito di Potenza	BLACK - BK		Control line at 230-24Vac Linea di Controllo a 230-24Vac	RED - RD	Control line at 24Vdc Linea di Controllo a 24Vdc	DARK BLUE - DBU	as circuit diagram indication	Analog signal Segnali Analogici	WHITE - WH	VIOLET - VT	Potential free contact Contatti Puri	BLUE - BU	Conductor not disconnected Conduttore non sezionati	ORANGE - OR		Ground or Earth connection Connessioni di Terra	GREEN/YELLOW - GN/YE	<table border="1"> <tr> <th>NFPA</th> <th>IEC</th> <th>DESCRIZIONE</th> </tr> <tr> <td> DS</td> <td> QS</td> <td>GENERAL SWITCH DÉBRANCHEUR PRINCIPAL</td> </tr> <tr> <td> CB</td> <td> QM</td> <td>AUTOMATIC THERMAL SWITCH INTERRUPTEUR THERMIQUE AUTOMATIQUE</td> </tr> <tr> <td> M</td> <td> KM</td> <td>COMPRESSOR CONTACT CONTACT COMPRESSEUR</td> </tr> <tr> <td> MOT</td> <td> MA</td> <td>MOTOR MOTEUR</td> </tr> <tr> <td> FU</td> <td> FU</td> <td>FUSES FUSIBLES</td> </tr> <tr> <td> CR</td> <td> KA</td> <td>NC RELAY CF RELAIS</td> </tr> <tr> <td> CR</td> <td> KA</td> <td>NO RELAY OC RELAIS</td> </tr> <tr> <td rowspan="2">C</td> <td rowspan="2"> <table border="1"> <tr> <th>NFPA</th> <th>IEC</th> <th>DESCRIZIONE</th> </tr> <tr> <td> XF</td> <td> XF</td> <td>TRANSFORMER TRANSFORMATEUR</td> </tr> <tr> <td> PS</td> <td> SP</td> <td>HIGH PRESSURE SWITCH PRESSOSTAT HAUTE PRESSION</td> </tr> <tr> <td> PS</td> <td> SP</td> <td>LOW PRESSURE SWITCH PRESSOSTAT BASSE PRESSION</td> </tr> <tr> <td> LS</td> <td> SL</td> <td>CONDENSATE LEVEL SENSOR CAPTEUR DE NIVEAU DE CONDENSAT</td> </tr> <tr> <td rowspan="2">D</td> <td rowspan="2"> <table border="1"> <tr> <th>NFPA</th> <th>IEC</th> <th>DESCRIZIONE</th> </tr> <tr> <td> SOL</td> <td> YV</td> <td>SOLENOID VALVE ELECTROVANNE</td> </tr> <tr> <td> CR</td> <td> KA</td> <td>RELAY COIL RELAIS DE BOBINE</td> </tr> <tr> <td> M</td> <td> KM</td> <td>CONTACTOR COIL CONTACTEUR DE BOBINE</td> </tr> <tr> <td rowspan="2">E</td> <td rowspan="2"> <table border="1"> <tr> <th>NFPA</th> <th>IEC</th> <th>DESCRIZIONE</th> </tr> <tr> <td> RA</td> <td> BT</td> <td>TEMPERATURE SENSOR CAPTEUR DE TEMPERATURE</td> </tr> <tr> <td> TB</td> <td> X</td> <td>THERMINAL BLOCK PINCE</td> </tr> <tr> <td> RE</td> <td> EH</td> <td>CARTER HEATER RÉSISTANCE AU CARTER</td> </tr> <tr> <td rowspan="2">F</td> <td rowspan="2"> <table border="1"> <tr> <th>NFPA</th> <th>IEC</th> <th>DESCRIZIONE</th> </tr> <tr> <td> PJ</td> <td> PJ</td> <td>SOCKET PRISE</td> </tr> </table> </td> <td></td> </tr> </table></td></tr></table></td></tr></table></td></tr></table>	NFPA	IEC	DESCRIZIONE	DS	QS	GENERAL SWITCH DÉBRANCHEUR PRINCIPAL	CB	QM	AUTOMATIC THERMAL SWITCH INTERRUPTEUR THERMIQUE AUTOMATIQUE	M	KM	COMPRESSOR CONTACT CONTACT COMPRESSEUR	MOT	MA	MOTOR MOTEUR	FU	FU	FUSES FUSIBLES	CR	KA	NC RELAY CF RELAIS	CR	KA	NO RELAY OC RELAIS	C	<table border="1"> <tr> <th>NFPA</th> <th>IEC</th> <th>DESCRIZIONE</th> </tr> <tr> <td> XF</td> <td> XF</td> <td>TRANSFORMER TRANSFORMATEUR</td> </tr> <tr> <td> PS</td> <td> SP</td> <td>HIGH PRESSURE SWITCH PRESSOSTAT HAUTE PRESSION</td> </tr> <tr> <td> PS</td> <td> SP</td> <td>LOW PRESSURE SWITCH PRESSOSTAT BASSE PRESSION</td> </tr> <tr> <td> LS</td> <td> SL</td> <td>CONDENSATE LEVEL SENSOR CAPTEUR DE NIVEAU DE CONDENSAT</td> </tr> <tr> <td rowspan="2">D</td> <td rowspan="2"> <table border="1"> <tr> <th>NFPA</th> <th>IEC</th> <th>DESCRIZIONE</th> </tr> <tr> <td> SOL</td> <td> YV</td> <td>SOLENOID VALVE ELECTROVANNE</td> </tr> <tr> <td> CR</td> <td> KA</td> <td>RELAY COIL RELAIS DE BOBINE</td> </tr> <tr> <td> M</td> <td> KM</td> <td>CONTACTOR COIL CONTACTEUR DE BOBINE</td> </tr> <tr> <td rowspan="2">E</td> <td rowspan="2"> <table border="1"> <tr> <th>NFPA</th> <th>IEC</th> <th>DESCRIZIONE</th> </tr> <tr> <td> RA</td> <td> BT</td> <td>TEMPERATURE SENSOR CAPTEUR DE TEMPERATURE</td> </tr> <tr> <td> TB</td> <td> X</td> <td>THERMINAL BLOCK PINCE</td> </tr> <tr> <td> RE</td> <td> EH</td> <td>CARTER HEATER RÉSISTANCE AU CARTER</td> </tr> <tr> <td rowspan="2">F</td> <td rowspan="2"> <table border="1"> <tr> <th>NFPA</th> <th>IEC</th> <th>DESCRIZIONE</th> </tr> <tr> <td> PJ</td> <td> PJ</td> <td>SOCKET PRISE</td> </tr> </table> </td> <td></td> </tr> </table></td></tr></table></td></tr></table>	NFPA	IEC	DESCRIZIONE	XF	XF	TRANSFORMER TRANSFORMATEUR	PS	SP	HIGH PRESSURE SWITCH PRESSOSTAT HAUTE PRESSION	PS	SP	LOW PRESSURE SWITCH PRESSOSTAT BASSE PRESSION	LS	SL	CONDENSATE LEVEL SENSOR CAPTEUR DE NIVEAU DE CONDENSAT	D	<table border="1"> <tr> <th>NFPA</th> <th>IEC</th> <th>DESCRIZIONE</th> </tr> <tr> <td> SOL</td> <td> YV</td> <td>SOLENOID VALVE ELECTROVANNE</td> </tr> <tr> <td> CR</td> <td> KA</td> <td>RELAY COIL RELAIS DE BOBINE</td> </tr> <tr> <td> M</td> <td> KM</td> <td>CONTACTOR COIL CONTACTEUR DE BOBINE</td> </tr> <tr> <td rowspan="2">E</td> <td rowspan="2"> <table border="1"> <tr> <th>NFPA</th> <th>IEC</th> <th>DESCRIZIONE</th> </tr> <tr> <td> RA</td> <td> BT</td> <td>TEMPERATURE SENSOR CAPTEUR DE TEMPERATURE</td> </tr> <tr> <td> TB</td> <td> X</td> <td>THERMINAL BLOCK PINCE</td> </tr> <tr> <td> RE</td> <td> EH</td> <td>CARTER HEATER RÉSISTANCE AU CARTER</td> </tr> <tr> <td rowspan="2">F</td> <td rowspan="2"> <table border="1"> <tr> <th>NFPA</th> <th>IEC</th> <th>DESCRIZIONE</th> </tr> <tr> <td> PJ</td> <td> PJ</td> <td>SOCKET PRISE</td> </tr> </table> </td> <td></td> </tr> </table></td></tr></table>	NFPA	IEC	DESCRIZIONE	SOL	YV	SOLENOID VALVE ELECTROVANNE	CR	KA	RELAY COIL RELAIS DE BOBINE	M	KM	CONTACTOR COIL CONTACTEUR DE BOBINE	E	<table border="1"> <tr> <th>NFPA</th> <th>IEC</th> <th>DESCRIZIONE</th> </tr> <tr> <td> RA</td> <td> BT</td> <td>TEMPERATURE SENSOR CAPTEUR DE TEMPERATURE</td> </tr> <tr> <td> TB</td> <td> X</td> <td>THERMINAL BLOCK PINCE</td> </tr> <tr> <td> RE</td> <td> EH</td> <td>CARTER HEATER RÉSISTANCE AU CARTER</td> </tr> <tr> <td rowspan="2">F</td> <td rowspan="2"> <table border="1"> <tr> <th>NFPA</th> <th>IEC</th> <th>DESCRIZIONE</th> </tr> <tr> <td> PJ</td> <td> PJ</td> <td>SOCKET PRISE</td> </tr> </table> </td> <td></td> </tr> </table>	NFPA	IEC	DESCRIZIONE	RA	BT	TEMPERATURE SENSOR CAPTEUR DE TEMPERATURE	TB	X	THERMINAL BLOCK PINCE	RE	EH	CARTER HEATER RÉSISTANCE AU CARTER	F	<table border="1"> <tr> <th>NFPA</th> <th>IEC</th> <th>DESCRIZIONE</th> </tr> <tr> <td> PJ</td> <td> PJ</td> <td>SOCKET PRISE</td> </tr> </table>	NFPA	IEC	DESCRIZIONE	PJ	PJ	SOCKET PRISE																											
		NFPA	IEC	DESCRIZIONE																																																																																																																																																																																															
FV	FV	PHASE MONITORING RELAY RELAIS DE SURVEILLANCE DE PHASE																																																																																																																																																																																																	
FV	FV	PHASE MONITORING RELAY RELAIS DE SURVEILLANCE DE PHASE																																																																																																																																																																																																	
XM	TM	SUPPLY TRANSFORMER TRASFORMATEUR DE PUISSANCE																																																																																																																																																																																																	
DS	QS	GENERAL SWITCH DÉBRANCHEUR PRINCIPAL																																																																																																																																																																																																	
Tightening Torque - Serrage du couple																																																																																																																																																																																																			
	Nm	ln*Lb																																																																																																																																																																																																	
QS1	6	53,1																																																																																																																																																																																																	
QM1	1,7	15,0																																																																																																																																																																																																	
QM1(aux)	1	8,9																																																																																																																																																																																																	
TM1	0,6	5,3																																																																																																																																																																																																	
KM1	3,2	28,9																																																																																																																																																																																																	
KM1(aux)	1,2	10,6																																																																																																																																																																																																	
KM3	1,2	10,6																																																																																																																																																																																																	
KM3(aux)	1,2	10,6																																																																																																																																																																																																	
E0	6	53,1																																																																																																																																																																																																	
fu(10,3X38)	2,3	20,4																																																																																																																																																																																																	
fu(5X20)	0,5	4,4																																																																																																																																																																																																	
FV6	0,8	7,1																																																																																																																																																																																																	
A1,A2,A3(in)	0,2	1,8																																																																																																																																																																																																	
A1,A2,A3(out)	0,6	5,3																																																																																																																																																																																																	
Designation Color in according to UL508A Colour Abbreviations in according to IEC 60757																																																																																																																																																																																																			
WIRING	COLOR	CROSS SECTION																																																																																																																																																																																																	
Power circuit Circuito di Potenza	BLACK - BK																																																																																																																																																																																																		
Control line at 230-24Vac Linea di Controllo a 230-24Vac	RED - RD																																																																																																																																																																																																		
Control line at 24Vdc Linea di Controllo a 24Vdc	DARK BLUE - DBU	as circuit diagram indication																																																																																																																																																																																																	
Analog signal Segnali Analogici	WHITE - WH																																																																																																																																																																																																		
	VIOLET - VT																																																																																																																																																																																																		
Potential free contact Contatti Puri	BLUE - BU																																																																																																																																																																																																		
Conductor not disconnected Conduttore non sezionati	ORANGE - OR																																																																																																																																																																																																		
Ground or Earth connection Connessioni di Terra	GREEN/YELLOW - GN/YE																																																																																																																																																																																																		
NFPA	IEC	DESCRIZIONE																																																																																																																																																																																																	
DS	QS	GENERAL SWITCH DÉBRANCHEUR PRINCIPAL																																																																																																																																																																																																	
CB	QM	AUTOMATIC THERMAL SWITCH INTERRUPTEUR THERMIQUE AUTOMATIQUE																																																																																																																																																																																																	
M	KM	COMPRESSOR CONTACT CONTACT COMPRESSEUR																																																																																																																																																																																																	
MOT	MA	MOTOR MOTEUR																																																																																																																																																																																																	
FU	FU	FUSES FUSIBLES																																																																																																																																																																																																	
CR	KA	NC RELAY CF RELAIS																																																																																																																																																																																																	
CR	KA	NO RELAY OC RELAIS																																																																																																																																																																																																	
C	<table border="1"> <tr> <th>NFPA</th> <th>IEC</th> <th>DESCRIZIONE</th> </tr> <tr> <td> XF</td> <td> XF</td> <td>TRANSFORMER TRANSFORMATEUR</td> </tr> <tr> <td> PS</td> <td> SP</td> <td>HIGH PRESSURE SWITCH PRESSOSTAT HAUTE PRESSION</td> </tr> <tr> <td> PS</td> <td> SP</td> <td>LOW PRESSURE SWITCH PRESSOSTAT BASSE PRESSION</td> </tr> <tr> <td> LS</td> <td> SL</td> <td>CONDENSATE LEVEL SENSOR CAPTEUR DE NIVEAU DE CONDENSAT</td> </tr> <tr> <td rowspan="2">D</td> <td rowspan="2"> <table border="1"> <tr> <th>NFPA</th> <th>IEC</th> <th>DESCRIZIONE</th> </tr> <tr> <td> SOL</td> <td> YV</td> <td>SOLENOID VALVE ELECTROVANNE</td> </tr> <tr> <td> CR</td> <td> KA</td> <td>RELAY COIL RELAIS DE BOBINE</td> </tr> <tr> <td> M</td> <td> KM</td> <td>CONTACTOR COIL CONTACTEUR DE BOBINE</td> </tr> <tr> <td rowspan="2">E</td> <td rowspan="2"> <table border="1"> <tr> <th>NFPA</th> <th>IEC</th> <th>DESCRIZIONE</th> </tr> <tr> <td> RA</td> <td> BT</td> <td>TEMPERATURE SENSOR CAPTEUR DE TEMPERATURE</td> </tr> <tr> <td> TB</td> <td> X</td> <td>THERMINAL BLOCK PINCE</td> </tr> <tr> <td> RE</td> <td> EH</td> <td>CARTER HEATER RÉSISTANCE AU CARTER</td> </tr> <tr> <td rowspan="2">F</td> <td rowspan="2"> <table border="1"> <tr> <th>NFPA</th> <th>IEC</th> <th>DESCRIZIONE</th> </tr> <tr> <td> PJ</td> <td> PJ</td> <td>SOCKET PRISE</td> </tr> </table> </td> <td></td> </tr> </table></td></tr></table></td></tr></table>	NFPA	IEC	DESCRIZIONE	XF	XF	TRANSFORMER TRANSFORMATEUR	PS	SP	HIGH PRESSURE SWITCH PRESSOSTAT HAUTE PRESSION	PS	SP	LOW PRESSURE SWITCH PRESSOSTAT BASSE PRESSION	LS	SL	CONDENSATE LEVEL SENSOR CAPTEUR DE NIVEAU DE CONDENSAT	D	<table border="1"> <tr> <th>NFPA</th> <th>IEC</th> <th>DESCRIZIONE</th> </tr> <tr> <td> SOL</td> <td> YV</td> <td>SOLENOID VALVE ELECTROVANNE</td> </tr> <tr> <td> CR</td> <td> KA</td> <td>RELAY COIL RELAIS DE BOBINE</td> </tr> <tr> <td> M</td> <td> KM</td> <td>CONTACTOR COIL CONTACTEUR DE BOBINE</td> </tr> <tr> <td rowspan="2">E</td> <td rowspan="2"> <table border="1"> <tr> <th>NFPA</th> <th>IEC</th> <th>DESCRIZIONE</th> </tr> <tr> <td> RA</td> <td> BT</td> <td>TEMPERATURE SENSOR CAPTEUR DE TEMPERATURE</td> </tr> <tr> <td> TB</td> <td> X</td> <td>THERMINAL BLOCK PINCE</td> </tr> <tr> <td> RE</td> <td> EH</td> <td>CARTER HEATER RÉSISTANCE AU CARTER</td> </tr> <tr> <td rowspan="2">F</td> <td rowspan="2"> <table border="1"> <tr> <th>NFPA</th> <th>IEC</th> <th>DESCRIZIONE</th> </tr> <tr> <td> PJ</td> <td> PJ</td> <td>SOCKET PRISE</td> </tr> </table> </td> <td></td> </tr> </table></td></tr></table>	NFPA	IEC	DESCRIZIONE	SOL	YV	SOLENOID VALVE ELECTROVANNE	CR	KA	RELAY COIL RELAIS DE BOBINE	M	KM	CONTACTOR COIL CONTACTEUR DE BOBINE	E	<table border="1"> <tr> <th>NFPA</th> <th>IEC</th> <th>DESCRIZIONE</th> </tr> <tr> <td> RA</td> <td> BT</td> <td>TEMPERATURE SENSOR CAPTEUR DE TEMPERATURE</td> </tr> <tr> <td> TB</td> <td> X</td> <td>THERMINAL BLOCK PINCE</td> </tr> <tr> <td> RE</td> <td> EH</td> <td>CARTER HEATER RÉSISTANCE AU CARTER</td> </tr> <tr> <td rowspan="2">F</td> <td rowspan="2"> <table border="1"> <tr> <th>NFPA</th> <th>IEC</th> <th>DESCRIZIONE</th> </tr> <tr> <td> PJ</td> <td> PJ</td> <td>SOCKET PRISE</td> </tr> </table> </td> <td></td> </tr> </table>	NFPA	IEC	DESCRIZIONE	RA	BT	TEMPERATURE SENSOR CAPTEUR DE TEMPERATURE	TB	X	THERMINAL BLOCK PINCE	RE	EH	CARTER HEATER RÉSISTANCE AU CARTER	F	<table border="1"> <tr> <th>NFPA</th> <th>IEC</th> <th>DESCRIZIONE</th> </tr> <tr> <td> PJ</td> <td> PJ</td> <td>SOCKET PRISE</td> </tr> </table>	NFPA	IEC	DESCRIZIONE	PJ	PJ	SOCKET PRISE																																																																																																																																															
		NFPA	IEC	DESCRIZIONE																																																																																																																																																																																															
XF	XF	TRANSFORMER TRANSFORMATEUR																																																																																																																																																																																																	
PS	SP	HIGH PRESSURE SWITCH PRESSOSTAT HAUTE PRESSION																																																																																																																																																																																																	
PS	SP	LOW PRESSURE SWITCH PRESSOSTAT BASSE PRESSION																																																																																																																																																																																																	
LS	SL	CONDENSATE LEVEL SENSOR CAPTEUR DE NIVEAU DE CONDENSAT																																																																																																																																																																																																	
D	<table border="1"> <tr> <th>NFPA</th> <th>IEC</th> <th>DESCRIZIONE</th> </tr> <tr> <td> SOL</td> <td> YV</td> <td>SOLENOID VALVE ELECTROVANNE</td> </tr> <tr> <td> CR</td> <td> KA</td> <td>RELAY COIL RELAIS DE BOBINE</td> </tr> <tr> <td> M</td> <td> KM</td> <td>CONTACTOR COIL CONTACTEUR DE BOBINE</td> </tr> <tr> <td rowspan="2">E</td> <td rowspan="2"> <table border="1"> <tr> <th>NFPA</th> <th>IEC</th> <th>DESCRIZIONE</th> </tr> <tr> <td> RA</td> <td> BT</td> <td>TEMPERATURE SENSOR CAPTEUR DE TEMPERATURE</td> </tr> <tr> <td> TB</td> <td> X</td> <td>THERMINAL BLOCK PINCE</td> </tr> <tr> <td> RE</td> <td> EH</td> <td>CARTER HEATER RÉSISTANCE AU CARTER</td> </tr> <tr> <td rowspan="2">F</td> <td rowspan="2"> <table border="1"> <tr> <th>NFPA</th> <th>IEC</th> <th>DESCRIZIONE</th> </tr> <tr> <td> PJ</td> <td> PJ</td> <td>SOCKET PRISE</td> </tr> </table> </td> <td></td> </tr> </table></td></tr></table>	NFPA	IEC	DESCRIZIONE	SOL	YV	SOLENOID VALVE ELECTROVANNE	CR	KA	RELAY COIL RELAIS DE BOBINE	M	KM	CONTACTOR COIL CONTACTEUR DE BOBINE	E	<table border="1"> <tr> <th>NFPA</th> <th>IEC</th> <th>DESCRIZIONE</th> </tr> <tr> <td> RA</td> <td> BT</td> <td>TEMPERATURE SENSOR CAPTEUR DE TEMPERATURE</td> </tr> <tr> <td> TB</td> <td> X</td> <td>THERMINAL BLOCK PINCE</td> </tr> <tr> <td> RE</td> <td> EH</td> <td>CARTER HEATER RÉSISTANCE AU CARTER</td> </tr> <tr> <td rowspan="2">F</td> <td rowspan="2"> <table border="1"> <tr> <th>NFPA</th> <th>IEC</th> <th>DESCRIZIONE</th> </tr> <tr> <td> PJ</td> <td> PJ</td> <td>SOCKET PRISE</td> </tr> </table> </td> <td></td> </tr> </table>	NFPA	IEC	DESCRIZIONE	RA	BT	TEMPERATURE SENSOR CAPTEUR DE TEMPERATURE	TB	X	THERMINAL BLOCK PINCE	RE	EH	CARTER HEATER RÉSISTANCE AU CARTER	F	<table border="1"> <tr> <th>NFPA</th> <th>IEC</th> <th>DESCRIZIONE</th> </tr> <tr> <td> PJ</td> <td> PJ</td> <td>SOCKET PRISE</td> </tr> </table>	NFPA	IEC	DESCRIZIONE	PJ	PJ	SOCKET PRISE																																																																																																																																																																
		NFPA	IEC	DESCRIZIONE																																																																																																																																																																																															
SOL	YV	SOLENOID VALVE ELECTROVANNE																																																																																																																																																																																																	
CR	KA	RELAY COIL RELAIS DE BOBINE																																																																																																																																																																																																	
M	KM	CONTACTOR COIL CONTACTEUR DE BOBINE																																																																																																																																																																																																	
E	<table border="1"> <tr> <th>NFPA</th> <th>IEC</th> <th>DESCRIZIONE</th> </tr> <tr> <td> RA</td> <td> BT</td> <td>TEMPERATURE SENSOR CAPTEUR DE TEMPERATURE</td> </tr> <tr> <td> TB</td> <td> X</td> <td>THERMINAL BLOCK PINCE</td> </tr> <tr> <td> RE</td> <td> EH</td> <td>CARTER HEATER RÉSISTANCE AU CARTER</td> </tr> <tr> <td rowspan="2">F</td> <td rowspan="2"> <table border="1"> <tr> <th>NFPA</th> <th>IEC</th> <th>DESCRIZIONE</th> </tr> <tr> <td> PJ</td> <td> PJ</td> <td>SOCKET PRISE</td> </tr> </table> </td> <td></td> </tr> </table>	NFPA	IEC	DESCRIZIONE	RA	BT	TEMPERATURE SENSOR CAPTEUR DE TEMPERATURE	TB	X	THERMINAL BLOCK PINCE	RE	EH	CARTER HEATER RÉSISTANCE AU CARTER	F	<table border="1"> <tr> <th>NFPA</th> <th>IEC</th> <th>DESCRIZIONE</th> </tr> <tr> <td> PJ</td> <td> PJ</td> <td>SOCKET PRISE</td> </tr> </table>	NFPA	IEC	DESCRIZIONE	PJ	PJ	SOCKET PRISE																																																																																																																																																																														
		NFPA	IEC	DESCRIZIONE																																																																																																																																																																																															
RA	BT	TEMPERATURE SENSOR CAPTEUR DE TEMPERATURE																																																																																																																																																																																																	
TB	X	THERMINAL BLOCK PINCE																																																																																																																																																																																																	
RE	EH	CARTER HEATER RÉSISTANCE AU CARTER																																																																																																																																																																																																	
F	<table border="1"> <tr> <th>NFPA</th> <th>IEC</th> <th>DESCRIZIONE</th> </tr> <tr> <td> PJ</td> <td> PJ</td> <td>SOCKET PRISE</td> </tr> </table>	NFPA	IEC	DESCRIZIONE	PJ	PJ	SOCKET PRISE																																																																																																																																																																																												
		NFPA	IEC	DESCRIZIONE																																																																																																																																																																																															
PJ	PJ	SOCKET PRISE																																																																																																																																																																																																	

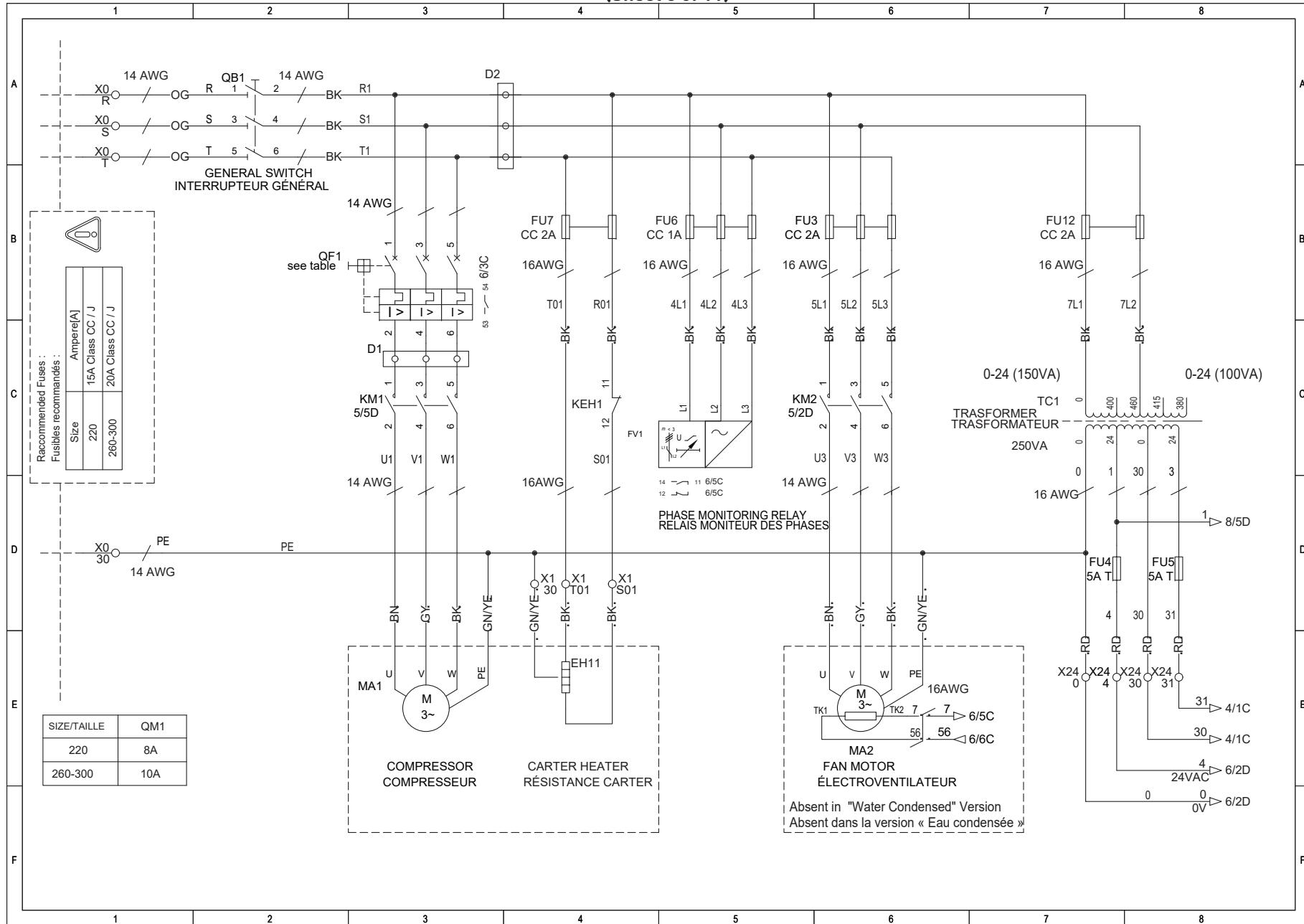

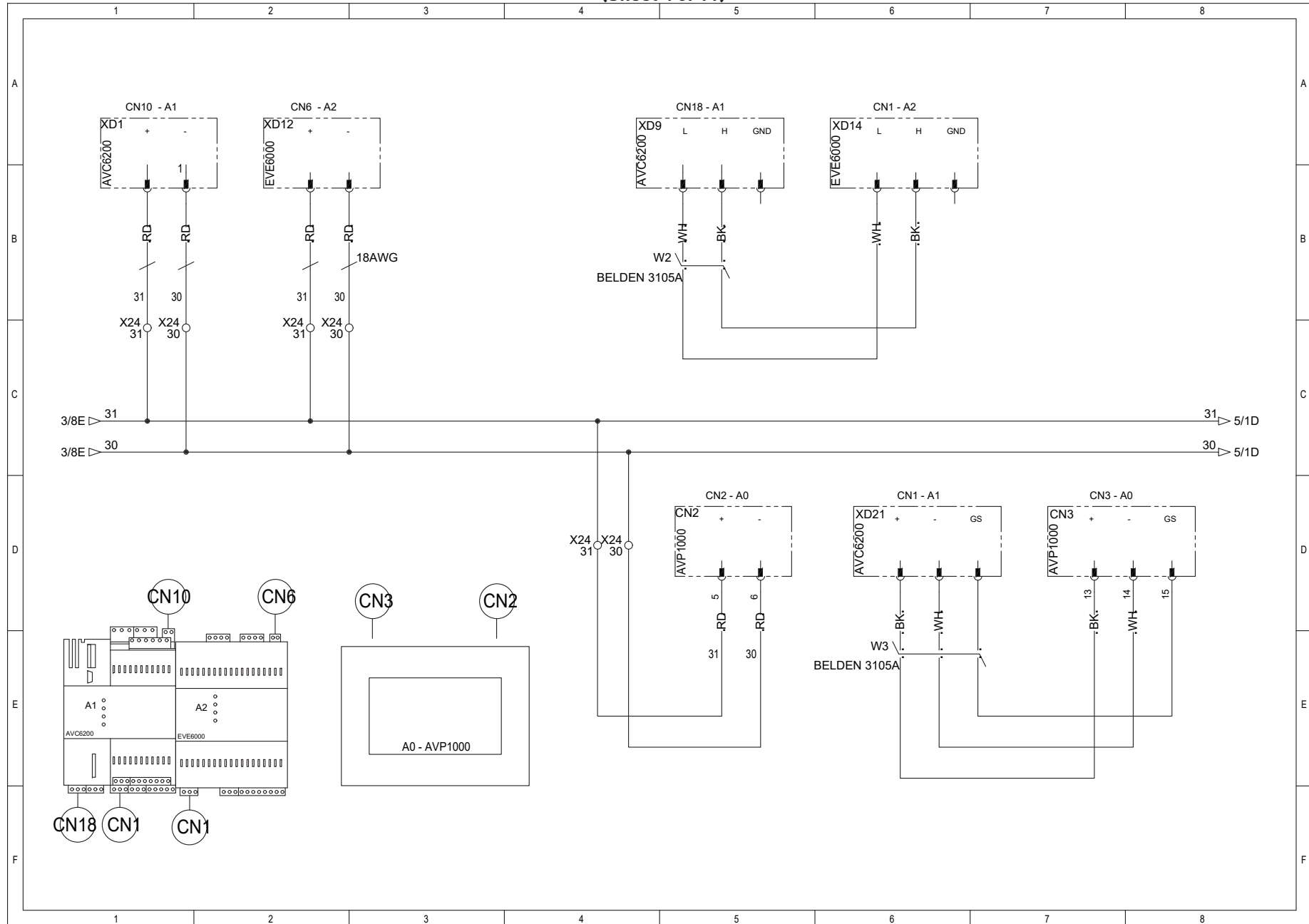

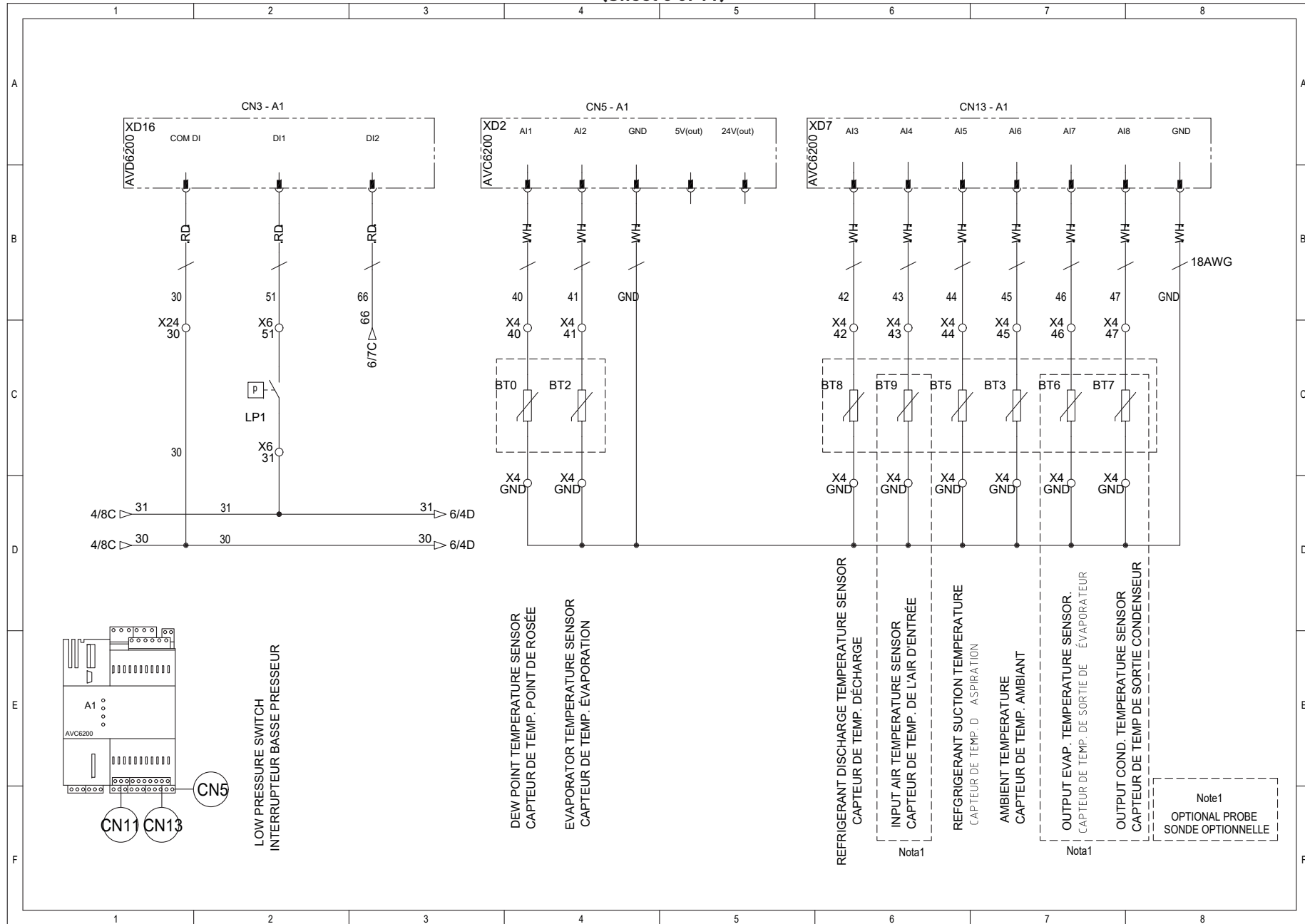

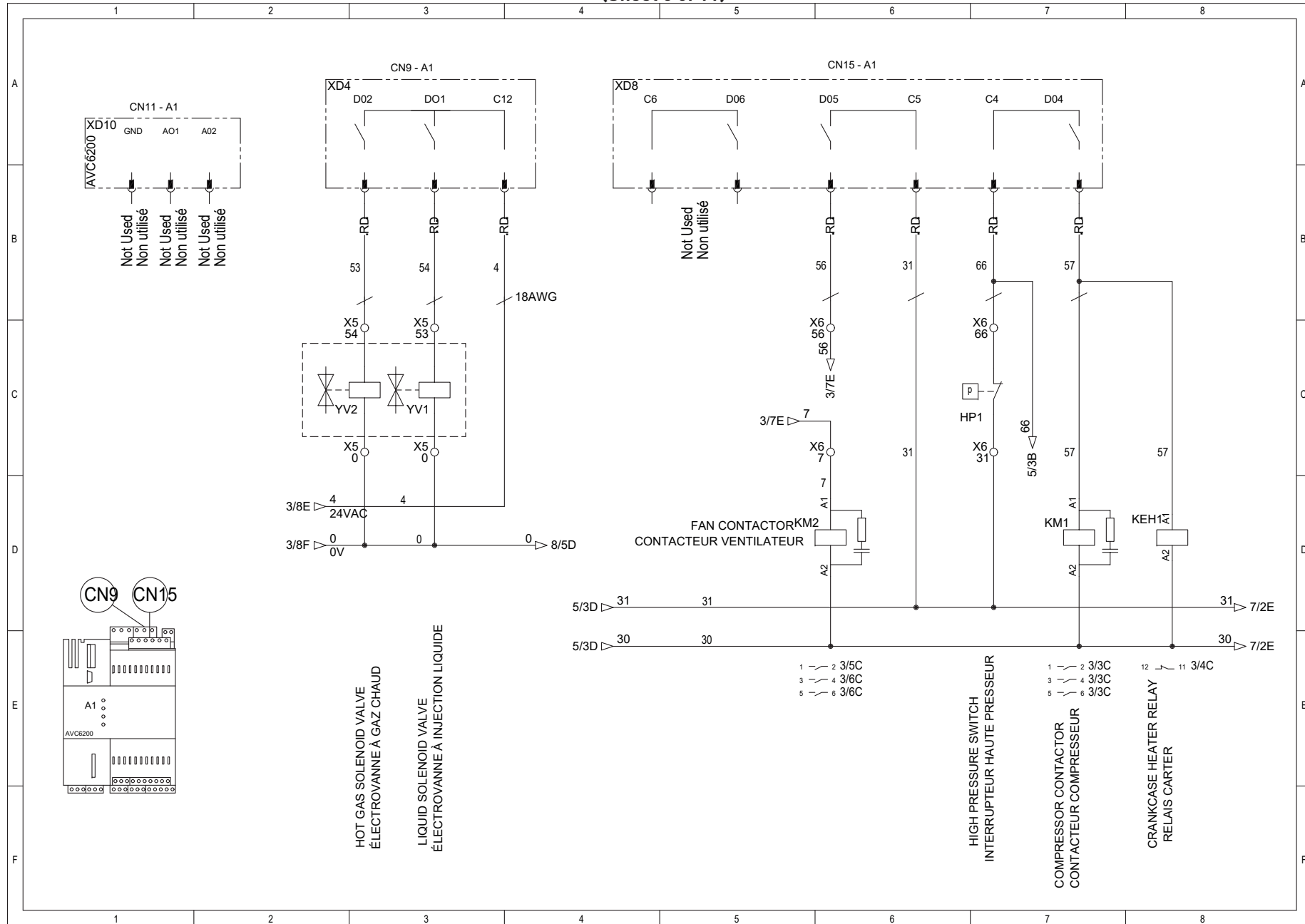

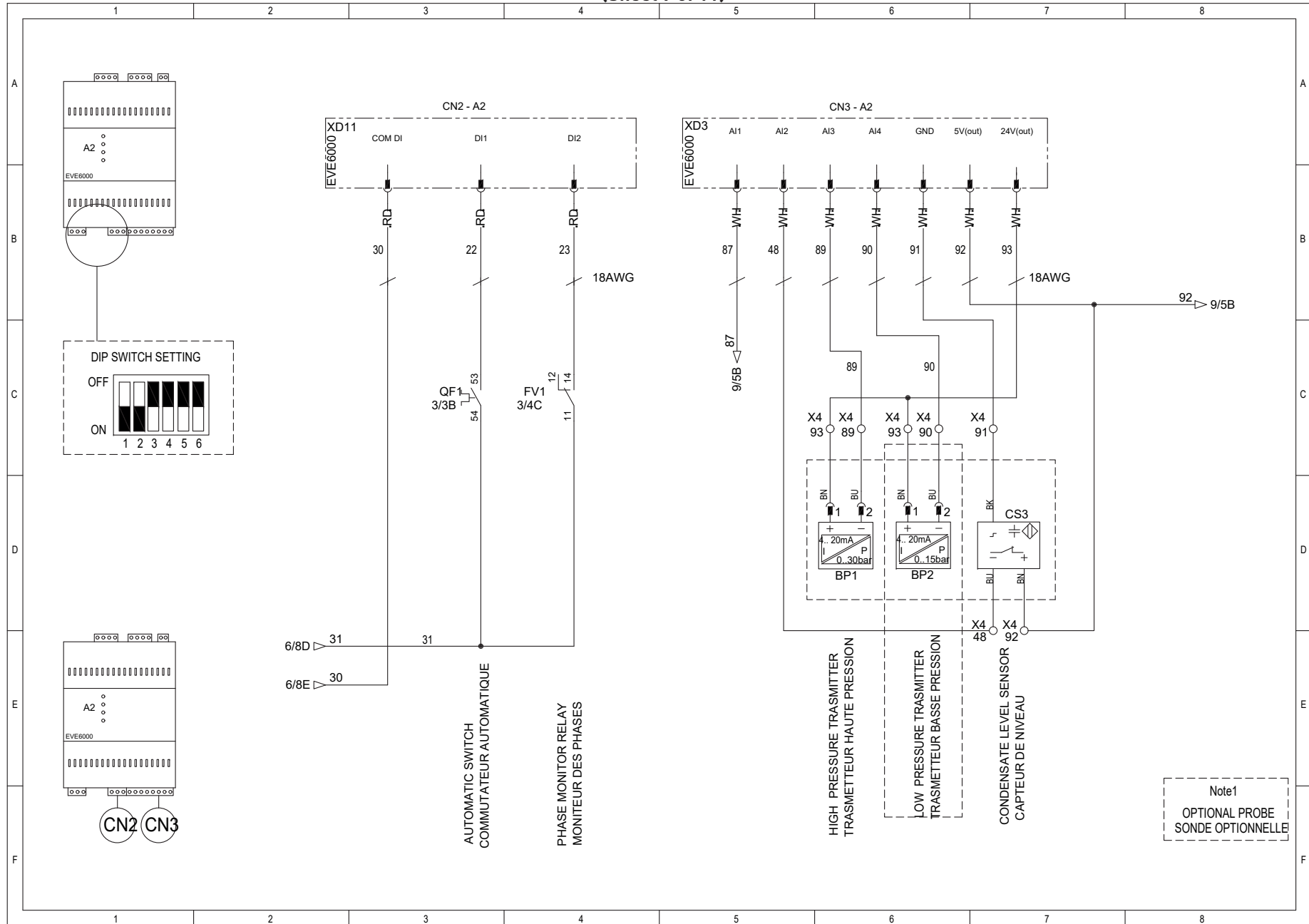

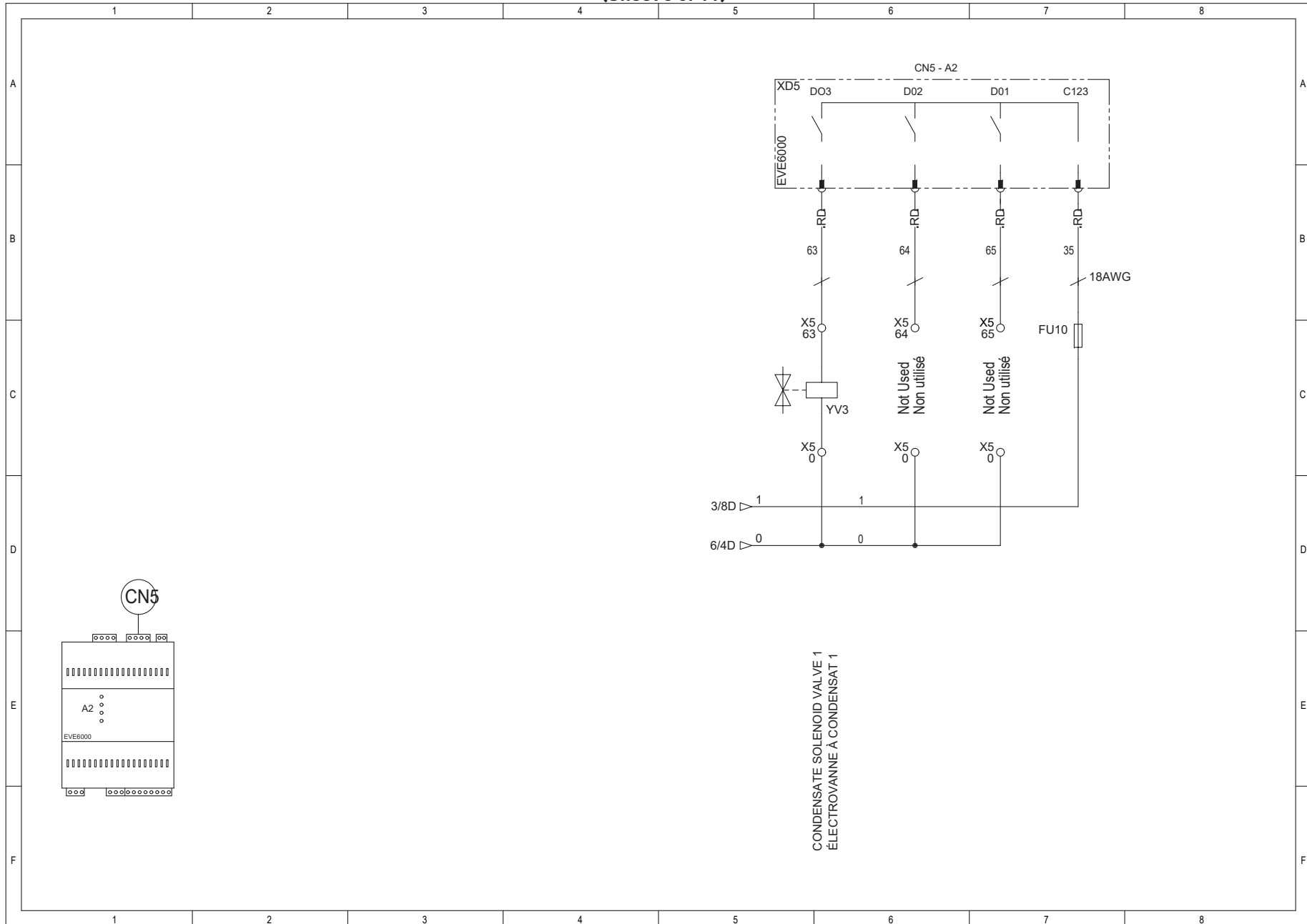

CONDENSATE SOLENOID VALVE 1
ÉLECTROVANNE À CONDENSAT 1

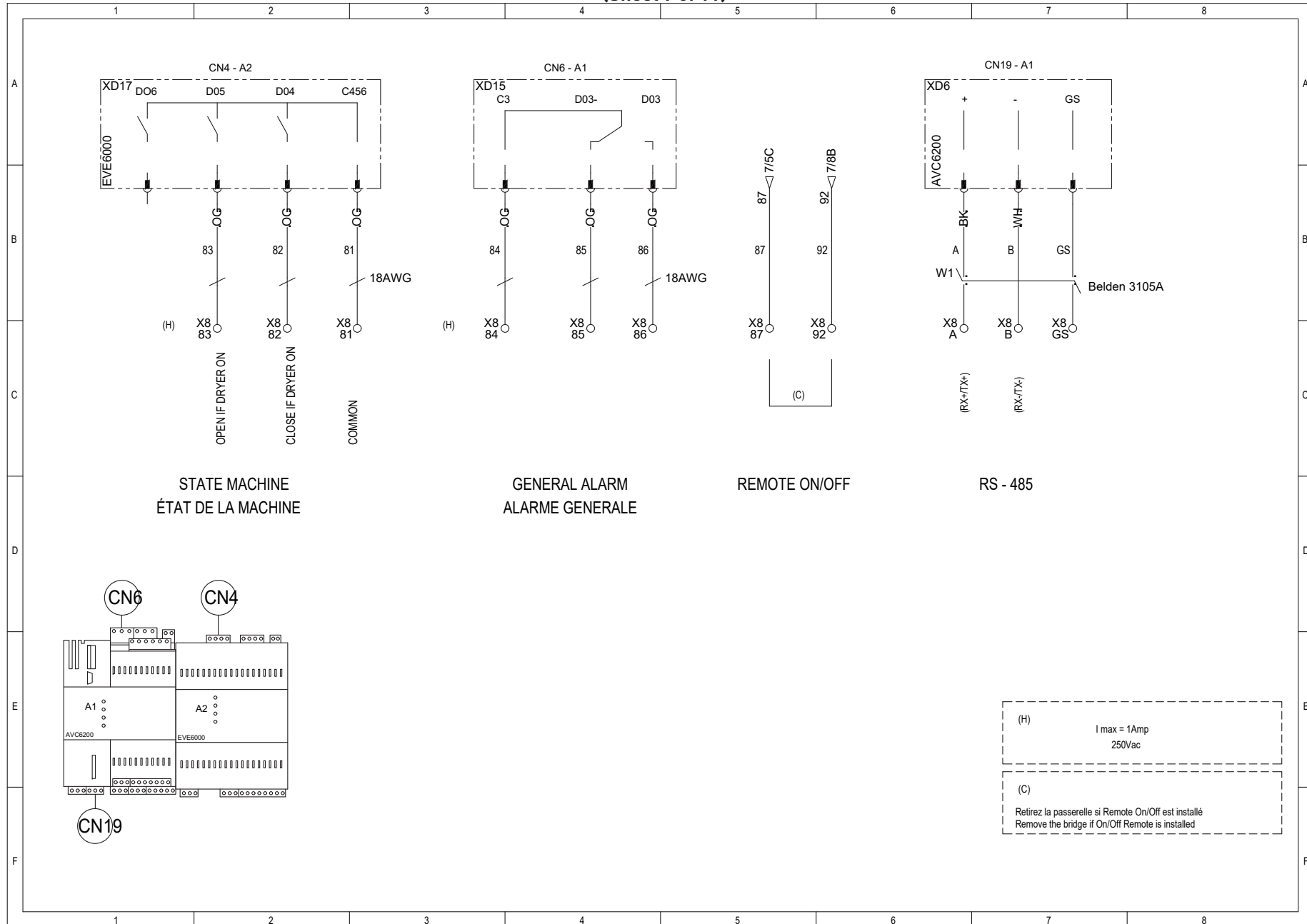

	1	2	3	4	5	6	7	8
A								
B	Terminal Block	X0	X1	X6	X8	X4		X5
	Terminal	R R S T PE	T01 T01 PE	66 66 51 51	7 56	A A B B GS GS	87 87 81 81 82 82 83 83	40 40 41 41 42 42 43 43 44 44 45 45 46 46 47 47 91 91 92 92 93 93 90 90
C	level down	R S T PE	S01 T01 PE	31 31	7	A B GS	87 81 82 83	40 41 42 43 44 45 46 47 91 92 93 90
	link down							
D	level up		T01	66 51			92 84 85 86	40 41 42 43 44 45 46 47 91 92 93 90
	link up							
E	wire up		BK BK GN/YE	66 51	7 56			
	wire down							
F			EH11 EH11	SPH1 SPL1	MA3	A+ B- GS	RO C NC NO	BT0 BT2 BT8 BT9 BT5 BT3 BT6 BT7 SL1 SL1 BP1 BP2
		power line	crankcase heater	refrigerant high pressure switch refrigerant low pressure switch	fan motor internal protection	Modbus RTU su RS485	remote ON/OFF plant status relay general alarm relay	ADS inlet temperature evaporator temperature refrigerant discharge temperature inlet air temperature refrigerant suction temperature ambient temperature outlet evaporatore temperature outlet condensatore temperature condensate level sensor condensate level sensor high pressure trasmitter low pressure trasmitter
	1	2	3	4	5	6	7	8

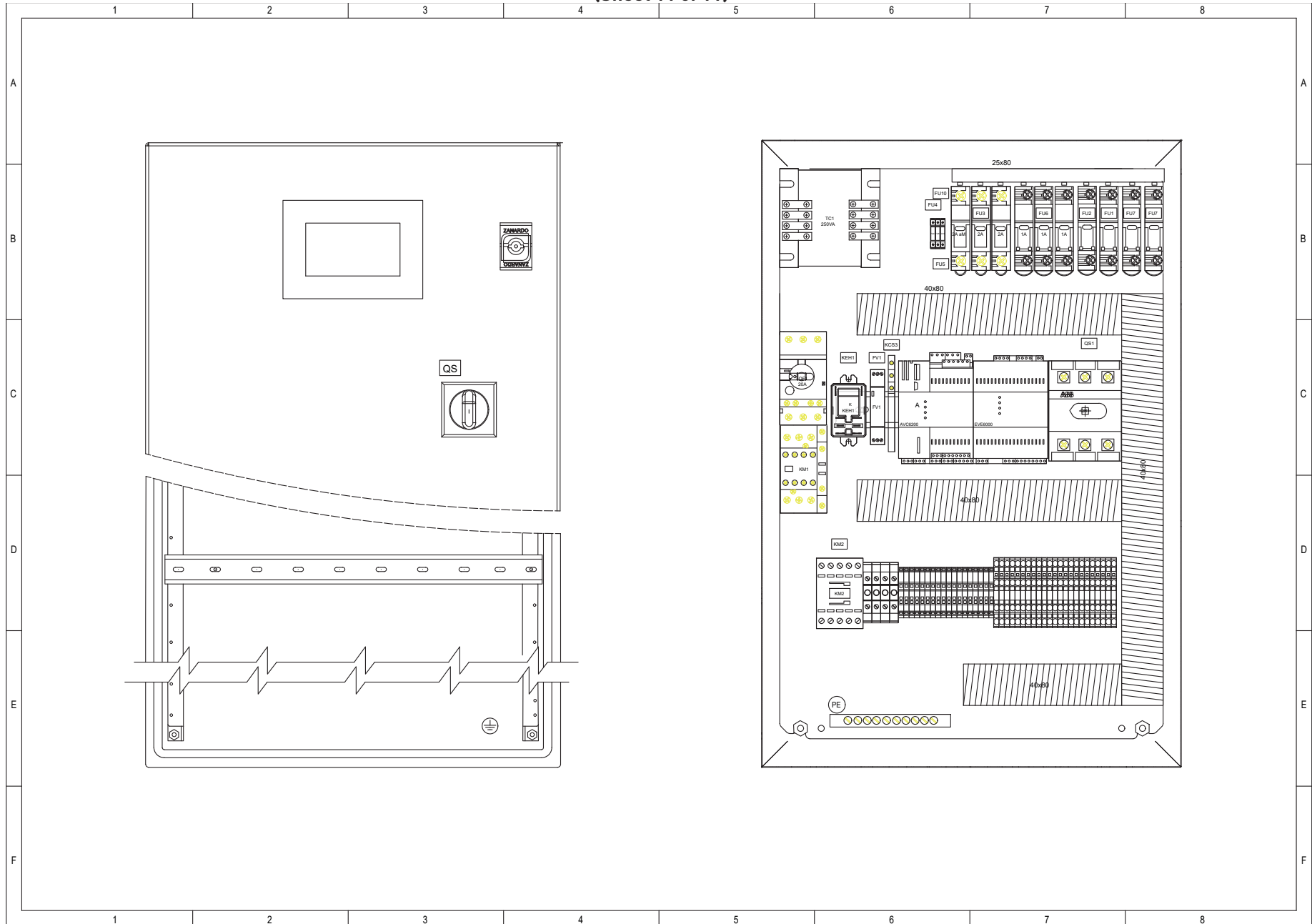



A division of Parker Hannifin Corporation

Parker Hannifin Corporation

Industrial Gas Filtration and Generation Division

4087 Walden Avenue

Lancaster, NY 14086

Tel: + 1 800 343 4048

Web site: www.parker.com/igfg

E-mail: gsfsupport@parker.com

Parker Hannifin Manufacturing S.r.l.

Sede Legale: Via Sebastiano Caboto 1, Palazzina "A" 20094 Corsico (MI) Italy

Sede Operativa: **Gas Separation and Filtration Division EMEA** - Strada Zona Industriale,

435020 S. Angelo di Piove (PD) Italy

tel +39 049 971 2111- fax +39 049 9701911

Web-site: www.parker.com